

Service Manual
HP Model 66312A
Dynamic Measurement DC Source
and HP Model 6612B
System DC Power Supply

For instruments with Serial Numbers:

HP 66312A: US36310101 and up

HP 6612B: US36340101 and up

HP Part No. 5962-0874
Microfiche No 6962-0875



Printed in U.S.A.
February, 1997

Warranty Information

CERTIFICATION

Hewlett-Packard Company certifies that this product met its published specifications at time of shipment from the factory. Hewlett-Packard further certifies that its calibration measurements are traceable to the United States National Bureau of Standards, to the extent allowed by the Bureau's calibration facility, and to the calibration facilities of other International Standards Organization members.

WARRANTY

This Hewlett-Packard hardware product is warranted against defects in material and workmanship for a period of three years from date of delivery. HP software and firmware products, which are designated by HP for use with a hardware product and when properly installed on that hardware product, are warranted not to fail to execute their programming instructions due to defects in material and workmanship for a period of 90 days from date of delivery. During the warranty period Hewlett-Packard Company will, at its option, either repair or replace products which prove to be defective. HP does not warrant that the operation for the software firmware, or hardware shall be uninterrupted or error free.

For warranty service, with the exception of warranty options, this product must be returned to a service facility designated by HP. Customer shall prepay shipping charges by (and shall pay all duty and taxes) for products returned to HP for warranty service. Except for products returned to Customer from another country, HP shall pay for return of products to Customer.

Warranty services outside the country of initial purchase are included in HP's product price, only if Customer pays HP international prices (defined as destination local currency price, or U.S. or Geneva Export price).

If HP is unable, within a reasonable time to repair or replace any product to condition as warranted, the Customer shall be entitled to a refund of the purchase price upon return of the product to HP.

LIMITATION OF WARRANTY

The foregoing warranty shall not apply to defects resulting from improper or inadequate maintenance by the Customer, Customer-supplied software or interfacing, unauthorized modification or misuse, operation outside of the environmental specifications for the product, or improper site preparation and maintenance. NO OTHER WARRANTY IS EXPRESSED OR IMPLIED. HP SPECIFICALLY DISCLAIMS THE IMPLIED WARRANTIES OF MERCHANTABILITY AND FITNESS FOR A PARTICULAR PURPOSE.

EXCLUSIVE REMEDIES

THE REMEDIES PROVIDED HEREIN ARE THE CUSTOMER'S SOLE AND EXCLUSIVE REMEDIES. HP SHALL NOT BE LIABLE FOR ANY DIRECT, INDIRECT, SPECIAL, INCIDENTAL, OR CONSEQUENTIAL DAMAGES, WHETHER BASED ON CONTRACT, TORT, OR ANY OTHER LEGAL THEORY.

ASSISTANCE

The above statements apply only to the standard product warranty. Warranty options, extended support contacts, product maintenance agreements and customer assistance agreements are also available. Contact your nearest Hewlett-Packard Sales and Service office for further information on HP's full line of Support Programs.

Safety Summary

The following general safety precautions must be observed during all phases of operation of this instrument. Failure to comply with these precautions or with specific warnings elsewhere in this manual violates safety standards of design, manufacture, and intended use of the instrument. Hewlett-Packard Company assumes no liability for the customer's failure to comply with these requirements.

WARNING

Servicing instructions are for use by service-trained personnel. To avoid dangerous electrical shock, do not perform any servicing unless you are qualified to do so. Some procedures described in this manual are performed with power supplied to the instrument while its protective covers are removed. If contacted, the energy available at many points may result in personal injury.

BEFORE APPLYING POWER.

Verify that the product is set to match the available line voltage, the correct line fuse is installed, and all safety precautions (see following warnings) are taken. In addition, note the instrument's external markings described under "Safety Symbols"

GROUND THE INSTRUMENT.

Before switching on the instrument, the protective earth terminal of the instrument must be connected to the protective conductor of the (mains) power cord. The mains plug shall be inserted only in an outlet socket that is provided with a protective earth contact. This protective action must not be negated by the use of an extension cord (power cable) that is without a protective conductor (grounding). Any interruption of the protective (grounding) conductor or disconnection of the protective earth terminal will cause a potential shock hazard that could result in personal injury.

FUSES

Only fuses with the required rated current, voltage, and specified type (normal blow, time delay, etc.) should be used. Do not use repaired fuses or short-circuited fuseholders. To do so could cause a shock or fire hazard.

KEEP AWAY FROM LIVE CIRCUITS.

Operating personnel must not remove instrument covers. Component replacement and internal adjustments must be made by qualified service personnel. Do not replace components with power cable connected. Under certain conditions, dangerous voltages may exist even with the power cable removed. To avoid injuries, always disconnect power, discharge circuits and remove external voltage sources before touching components.

DO NOT SERVICE OR ADJUST ALONE.

Do not attempt internal service or adjustment unless another person, capable of rendering first aid and resuscitation, is present. Any adjustment, maintenance, and repair of this instrument while it is opened and under voltage should be avoided as much as possible. When this is unavoidable, such adjustment, maintenance, and repair should be carried out only by a skilled person who is aware of the hazard involved.

DO NOT SUBSTITUTE PARTS OR MODIFY INSTRUMENT.



















Because of the danger of introducing additional hazards, do not install substitute parts or perform any unauthorized modification to the instrument. Return the instrument to a Hewlett-Packard Sales and Service Office for service and repair to ensure that safety features are maintained.

SAFETY SYMBOLS

Refer to the table on the following page

WARNING The WARNING sign denotes a hazard. It calls attention to a procedure, practice, or the like, which, if not correctly performed or adhered to, could result in personal injury. Do not proceed beyond a WARNING sign until the indicated conditions are fully understood and met.

Caution The CAUTION sign denotes a hazard. It calls attention to an operating procedure, or the like, which, if not correctly performed or adhered to, could result in damage to or destruction of part or all of the product. Do not proceed beyond a CAUTION sign until the indicated conditions are fully understood and met.

Safety Symbol Definitions	
Symbol	Description
	Direct current
	Alternating current
	Both direct and alternating current
	Three-phase alternating current
	Earth (ground) terminal
	Protective earth (ground) terminal
	Frame or chassis terminal
	Terminal is at earth potential (Used for measurement and control circuits designed to be operated with one terminal at earth potential.)
	Terminal for Neutral conductor on permanently installed equipment
	Terminal for Line conductor on permanently installed equipment
	On (supply)
	Off (supply)
	Standby (supply) Units with this symbol are not completely disconnected from ac mains when this switch is off. To completely disconnect the unit from ac mains, either disconnect the power cord or have a qualified electrician install an external switch.
	In position of a bi-stable push control
	Out position of a bi-stable push control
	Caution, risk of electric shock
	Caution, hot surface
	Caution (refer to accompanying documents)

Notice

The information contained in this document is subject to change without notice. Hewlett-Packard makes no warranty of any kind with regard to this material, including but not limited to, the implied warranties of merchantability, and fitness for a particular purpose.

Hewlett-Packard shall not be liable for errors contained herein or for incidental or consequential damages in connection with the furnishing, performance or use of this material.

This document contains proprietary information which is protected by copyright. All rights are reserved. No part of this document may be photocopied, reproduced, or translated into another language without the prior written consent of Hewlett-Packard Company.

© Copyright 1997 Hewlett-Packard Company

Printing History

The edition and current revision of this manual are indicated below. Reprints of this manual containing minor corrections and updates may have the same printing date. Revised editions are identified by a new printing date. A revised edition incorporates all new or corrected material since the previous printing date.

Changes to the manual occurring between revisions are covered by change sheets shipped with the manual. In some cases, the manual change applies only to specific instruments. Instructions provided on the change sheet will indicate if a particular change applies only to certain instruments.

Instrument Identification

The power supply is identified by a unique, two-part serial number, such as, 3601A-00101. The items in this serial number are explained as follows:

US36310101 The first two letters indicate the country of manufacture. US = United States.

The next four digits are the year and week of manufacture or last significant design change. Add 1960 to the first two digits to determine the year. For example, 36=1996. The third and fourth digits specify the week of the year (31 = the thirty-first week).

The last four digits (0101) are a unique number assigned to each unit.

Table of Contents

Warranty Information	2
Safety Summary	3
Notice	4
Printing History	5
Instrument Identification	5
Table of Contents	6
INTRODUCTION	9
Organization	9
Safety Considerations	9
Related Documents	9
Revisions	10
Manual Revisions	10
Firmware Revisions	10
Electrostatic Discharge	10
VERIFICATION AND PERFORMANCE TESTS	11
Introduction	11
Test Equipment Required	11
Measurement Techniques	12
Setup for Most Tests	12
Electronic Load	13
Current-Monitoring Resistor	13
Operation Verification Tests	13
Performance Tests	13
Programming	13
Constant Voltage (CV) Tests	14
CV Setup	14
Voltage Programming and Readback Accuracy	14
CV Load Effect	14
CV Source Effect	15
CV Noise (PARD)	15
Transient Recovery Time	16
Constant Current (CC) Tests	16
CC Setup	16
Current Programming and Readback Accuracy	16
Current Sink (CC-) Operation	17
CC Load and Line Regulation	17
CC Load Effect	18
CC Source Effect	18
CC Noise (PARD)	19
Performance Test Equipment Form	19
Performance Test Record Form	20
TROUBLESHOOTING	21
Introduction	21
Test Equipment Required	22
Overall Troubleshooting	22
Flow Charts	22

Specific Troubleshooting Procedures	33
Power-on Self-test Failures	36
CV/CC Status Annunciators Troubleshooting	37
Bias and Reference Supplies	37
J307 Voltage Measurements	38
Manual Fan Speed Control	39
Disabling Protection Features	39
Post-repair Calibration	40
Inhibit Calibration Switch	40
Calibration Password	40
Initialization	41
ROM Upgrade	41
Identifying the Firmware	41
Upgrade Procedure	41
Disassembly Procedures	42
List of Required Tools	42
Cover, Removal and Replacement	43
A2 Interface Board, Removal and Replacement	43
Front Panel Assembly, Removal and Replacement	43
A3 Front Panel Board, Removal and Replacement	44
A1 Main Control Board	44
T1 Power Transformer, Removal and Replacement	44
Line Voltage Wiring	44
PRINCIPLES OF OPERATION	47
Introduction	47
I/O Interface Signals	47
A3 Front Panel Circuits	48
A2 Interface Circuits	48
Primary Interface	48
Secondary Interface	48
A1 Main Board Circuits	50
Power Circuits	50
Control Circuits	52
REPLACEABLE PARTS LIST	55
Introduction	55
DIAGRAMS	65
Introduction	65
General Schematic Notes	65
Backdating	65
INDEX	73

Introduction

Organization

This manual contains information for troubleshooting and repairing to the component level the HP Model 66312A Dynamic Measurement DC Source and the HP Model 6612B System DC Power Supply. Hereafter both models will be referred to as the dc power supply.

This manual is organized as follows:

- Chapter 1** Organization
- Chapter 2** Performance tests
- Chapter 3** Troubleshooting procedures
- Chapter 4** Principles of operation on a block-diagram level
- Chapter 5** Replaceable parts
- Chapter 6** Diagrams

Safety Considerations

WARNING: Hazardous voltages exist within the dc power supply chassis.

This dc power supply; is a Safety Class I instrument, which means it has a protective earth terminal. This terminal must be connected to earth ground through a power source equipped with a 3-wire, ground receptacle. Refer to the "Safety Summary" page at the beginning of this manual for general safety information. Before operation or repair, check the dc power supply and review this manual for safety warnings and instructions. Safety warnings for specific procedures are located at appropriate places in the manual.

Related Documents

The following documents are shipped with your dc power supply:

- a User's Guide, containing installation, operating, and calibration information
- a Programming Guide, containing detailed HP-IB programming information.

Revisions

Manual Revisions

This manual was written for dc power supplies that have the same manufacturing dates (the first four digits) as those listed on the title page and whose unique identification number (the last four digits) are equal to or higher than those listed in the title page.

-
- NOTE:**
- 1) If the first four digits of the serial number of your unit are higher than those shown in the title page, your unit was made after the publication of this manual and may have hardware or firmware differences not covered in this manual. If they are significant to the operation and/or servicing of the dc power supply, those differences are documented in one or more Manual Change sheets included with this manual.
 - 2) If the first four digits of the serial number of your unit are lower than those shown on the title page, your unit was made before the publication of this manual and can be different from that described here. Such differences are covered in the backdating section in chapter 6.
-

Firmware Revisions

You can obtain the firmware revision number by either reading the integrated circuit label, or query the dc power supply using the HP-IB *IDN? query command (see chapter 3, ROM Upgrade).

Electrostatic Discharge

CAUTION: The dc power supply has components that can be damaged by ESD (electrostatic discharge). Failure to observe standard antistatic practices can result in serious degradation of performance, even when an actual failure does not occur.

When working on the dc power supply, observe all standard, antistatic work practices. These include, but are not limited to:

Working at a static-free station such as a table covered with static-dissipative laminate or with a conductive table mat (HP P/N 9300-0797, or equivalent).

Using a conductive wrist strap, such as HP P/N 9300-0969 or 9300-0970.

Grounding all metal equipment at the station to a single common ground.

Connecting low-impedance test equipment to static-sensitive components only when those components have power applied to them.

Removing power from the dc power supply before removing or installing printed circuit boards.

Verification and Performance Tests

Introduction

This document contains test procedures to verify that the dc power supply is operating normally and is within published specifications. There are three types of tests as follows:

Built-in Self Tests	These tests, run automatically when the power supply is turned on, check most of the digital circuits and the programming and readback DACs.
Operation Verification	These tests verify that the power supply is probably operating normally but do not check all of the specified operating parameters.
Performance Tests	These tests check that the supply meets all of the operating specifications as listed in the Operating Manual.

NOTE: The dc power supply must pass the built-in self-tests before calibration or any of the verification or performance tests can be performed. If the supply fails any of the tests or if abnormal test results are obtained, refer to the troubleshooting procedures in chapter 3. The troubleshooting procedures will determine if repair and/or calibration is required.

Test Equipment Required

Table 2-1 lists the equipment required to perform the verification and performance tests. A test record sheet with specification limits and measurement uncertainties (when test using the recommended test equipment) may be found at the back of this section.

WARNING: SHOCK HAZARD. These tests should only be performed by qualified personnel. During the performance of these tests, hazardous voltages may be present at the output of the supply.

Table 2-1. Test Equipment Required for Verification and Performance Tests

Type	Specifications	Recommended Model
Current Monitor Resistor	15 A (0.1 ohm) 0.04%, for power supplies up to 15 A output	Guildline 9230/15
DC Power Supply	Minimum 2.5 A output current rating	HP 6632B
Digital Voltmeter	Resolution: 10 nV @ 1V Readout: 8 1/2 digits Accuracy: 20 ppm	HP 3458A or equivalent
Electronic Load	20 V, 5 A minimum, with transient capability	HP 6060B or equivalent
HP-IB Controller	HP Series 300 or other controller with full HP-IB capabilities	
Resistor	1 ohm, 12 W (or 2 ohm adjustable)	Ohmite D12K2R0 (2 ohm adjustable)

2 - Verification and Performance Tests

(substitute for electronic load if load is too noisy for CC PARD test)	1 k ohm, 5%, 3 W 9 ohm, 100 W or Rheostat, 10 ohm, 150 W	HP p/n 0813-0001 Ohmite RLS10R (10 ohm adjustable) Ohmite 11F103
Oscilloscope	Sensitivity: 1 mV Bandwidth Limit: 20 MHz Probe: 1:1 with RF tip	HP 54504A or equivalent
RMS Voltmeter	True RMS Bandwidth: 20 MHz Sensitivity: 100 μ V	HP 3400B or equivalent
Variable-Voltage Transformer	Adjustable to highest rated input voltage range. Power: 500 VA	

Measurement Techniques

Test Setup

Most tests are performed at the rear terminals of the supply as shown in Figure 2-1a. Measure the dc voltage directly at the +S and -S terminals. If the Power Supply is equipped with a Local/Remote switch, set the switch to Remote and connect the output for remote sensing. Use adequate wire gauge for the load leads.

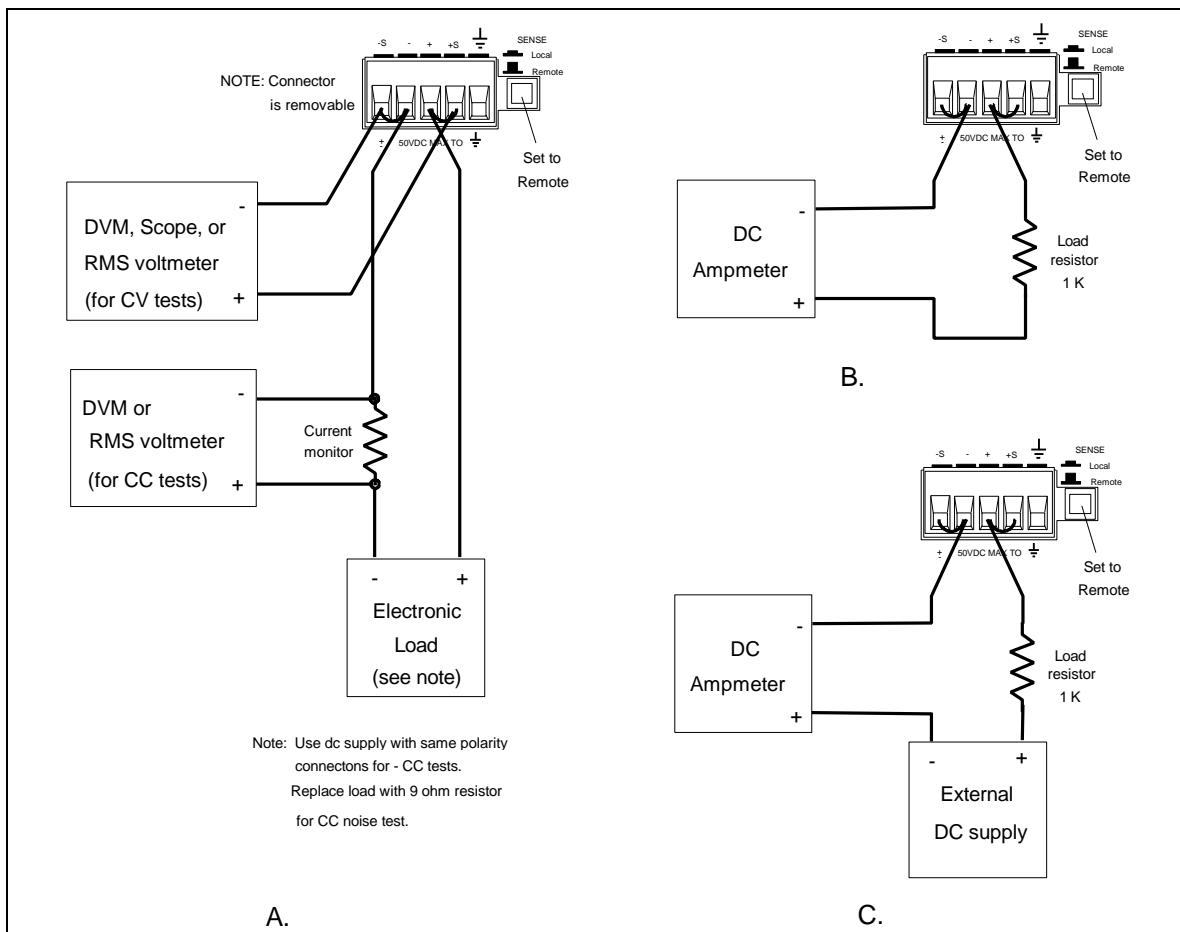

Figure 2-1. Test Setup

Electronic Load

Many of the test procedures require the use of a variable load capable of dissipating the required power. If a variable resistor is used, switches should be used to either; connect, disconnect, or short the load resistor. For most tests, an electronic load can be used. The electronic load is considerably easier to use than load resistors, but it may not be fast enough to test transient recovery time and may be too noisy for the noise (PARD) tests.

Fixed load resistors may be used in place of a variable load, with minor changes to the test procedures. Also, if computer controlled test setups are used, the relatively slow (compared to computers and system voltmeters) settling times and slew rates of the power supply may have to be taken into account. "Wait" statements can be used in the test program if the test system is faster than the supply.

Current-Monitoring Resistor

To eliminate output-current measurement error caused by voltage drops in the leads and connections, connect the current monitoring resistor between the -OUT and the load as a four-terminal device. Connect the current-monitoring leads inside the load-lead connections directly at the monitoring points on the resistor element.

Operation Verification Tests

To assure that the supply is operating properly, without testing all specified parameters, perform the following test procedures:

- a. Perform the turn-on and checkout procedures given in the Operating Manual.
- b. Perform the Voltage Programming and Readback Accuracy test, and the Current Programming and Readback Accuracy tests from this procedure.

Performance Tests

NOTE: A full Performance Test consists of only those items listed as "Specifications" in Table A-1 of the Operating Manual, and that have a procedure in this document.

The following paragraphs provide test procedures for verifying the supply's compliance with the specifications listed in Table A-1 of the Operating Manual. All of the performance test specifications and calculated measurement uncertainties are entered in the appropriate Performance Test Record Card for your specific model. You can record the actual measured values in the column provided in this card.

If you use equipment other than that recommended in Table 2-1, you must recalculate the measurement uncertainties for the actual equipment used.

Programming

You can program the supply from the front panel keyboard or from an HP-IB controller when performing the tests. The test procedures are written assuming that you know how to program the supply either; remotely from an HP-IB controller or locally using the control keys and indicators on the supply's front panel. Complete instructions on remote and local programming are given in the User's Guide and in the Programming Guide.

Constant Voltage (CV) Tests

CV Setup

If more than one meter or if a meter and an oscilloscope are used, connect each to the terminals by a separate pair of leads to avoid mutual coupling effects. For constant voltage dc tests, connect only to +S and -S, since the unit regulates the output voltage that appears between +S and -S, and not between the (+) and (-) output terminals. Use coaxial cable or shielded two-wire cable to avoid noise pickup on the test leads.

Voltage Programming and Readback Accuracy

This test verifies that the voltage programming, HP-IB readback and front panel display functions are within specifications. Note that the values read back over the HP-IB should be identical to those displayed on the front panel.

- a. Turn off the supply and connect a digital voltmeter between the +S and the -S terminals as shown in Figure 2-1a.
- b. Turn on the supply and program the supply to zero volts and the maximum programmable current with the load off.
- c. Record the output voltage readings on the digital voltmeter (DVM) and the front panel display. The readings should be within the limits specified in the performance test record chart for the appropriate model under CV PROGRAMMING @ 0 VOLTS. Also, note that the CV annunciator is on. The output current reading should be approximately zero.
- d. Program the output voltage to full-scale.
- e. Record the output voltage readings on the DVM and the front panel display. The readings should be within the limits specified in the performance test record chart for the appropriate model under CV PROGRAMMING @ FULL SCALE.

CV Load Effect

This test measures the change in output voltage resulting from a change in output current from full load to no load.

- a. Turn off the supply and connect the output as shown in Figure 2-1a with the DVM connected between the +S and -S terminals.
- b. Turn on the supply and program the current to the maximum programmable value and the voltage to the full-scale value.
- c. Adjust the load for the full-scale current as indicated on the front panel display. The CV annunciator on the front panel must be on. If it is not, adjust the load so that the output current drops slightly.
- d. Record the output voltage reading on the DVM connected to +S and -S.
- e. Open the load and again record the DVM voltage reading. The difference between the DVM readings in steps (d) and (e) is the load effect voltage, and should not exceed the value listed in the performance test record chart for the appropriate model under CV LOAD EFFECT.

CV Source Effect

This test measures the change in output voltage that results from a change in ac line voltage from the minimum to maximum value within the line voltage specifications.

- a. Turn off the supply and connect the ac power line through a variable voltage transformer.
- b. Connect the output as shown in Figure 2-1a with the DVM connected between the +S and the -S terminals. Set the transformer to nominal line voltage.
- c. Turn on the supply and program the current to the maximum programmable value and the output voltage to the full-scale value .
- d. Adjust the load for the full-scale current value as indicated on the front panel display. The CV annunciator on the front panel must be on. If it is not, adjust the load so that the output current drops slightly.
- e. Adjust the transformer to the lowest rated line voltage (e.g., 104 Vac for a 115 Vac nominal line voltage input).
- f. Record the output voltage reading on the DVM.
- g. Adjust the transformer to the highest rated line voltage (e.g., 127 Vac for 115 Vac nominal line voltage input).
- h. Record the output voltage reading on the DVM. The difference between the DVM reading is steps (f) and (h) is the source effect voltage and should not exceed the value listed in the performance test record chart for the appropriate model under CV SOURCE EFFECT.

CV Noise (PARD)

Periodic and random deviations (PARD) in the output (ripple and noise) combine to produce a residual ac voltage superimposed on the dc output voltage. CV PARD is specified as the rms or peak-to-peak output voltage in the frequency range specified in the User's Guide.

- a. Turn off the supply and connect the output as shown in Figure 2-1a to an oscilloscope (ac coupled) between the (+) and the (-) terminals. Set the oscilloscope's bandwidth limit to 20 MHz and use an RF tip on the oscilloscope probe.
- b. Turn on the supply and program the current to the maximum programmable value and the output voltage to the full-scale value.
- c. Adjust the load for the full-scale current value as indicated on the front panel display.
- d. Note that the waveform on the oscilloscope should not exceed the peak-to-peak limits in the performance test record chart for the appropriate model under CV NOISE (PARD).
- e. Disconnect the oscilloscope and connect an ac rms voltmeter in its place. The rms voltage reading should not exceed the RMS limits in the performance test record chart for the appropriate model under CV NOISE (PARD).

2 - Verification and Performance Tests

Transient Recovery Time

This test measures the time for the output voltage to recover to within the specified value following a 50% change in the load current.

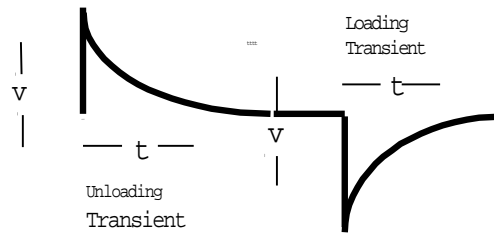

Figure 2-2. Transient Waveform

- Turn off the supply and connect the output as in Figure 2-1a with the oscilloscope across the +S and the -S terminals.
- Turn on the supply and program the output voltage to the full-scale value and the current to the maximum programmable value.
- Set the load to the Constant Current mode and program the load current to 1/2 the power supply full-scale rated current.
- Set the electronic load's transient generator frequency to 100 Hz and its duty cycle to 50%.
- Program the load's transient current level to the supply's full-scale current value and turn the transient generator on.
- Adjust the oscilloscope for a waveform similar to that in Figure 2-2.
- The output voltage should return to within the specified voltage (v) in less than the specified time (t). Check both loading and unloading transients by triggering on the positive and negative slope.

Constant Current (CC) Tests

CC Setup

Follow the general setup instructions in the Measurement Techniques paragraph and the specific instructions given in the following paragraphs.

Current Programming and Readback Accuracy

This test verifies that the current programming and readback are within specification.

- Turn off the supply and connect the current monitoring resistor across the power supply output and the DVM across the resistor. See "Current Monitoring Resistor" for connection information.
- Turn on the supply and program the output voltage to 5 V and the current to zero.
- Divide the voltage drop (DVM reading) across the current monitoring resistor by its resistance to convert to amps and record this value (I_{out}). Also, record the current reading on the front panel display. The readings should be within the limits specified in the performance test record card for the appropriate model under CC PROGRAMMING @ 0 AMPS.
- Program the output current to full-scale .

- e. Divide the voltage drop (DVM reading) across the current monitoring resistor by its resistance to convert to amps and record this value (I_{out}). Also, record the current reading that appears on the front panel display. The readings should be within the limits specified in the performance test record card for the appropriate model under CC PROGRAMMING @ FULL-SCALE.

Current Sink (-CC) Operation

This test verifies current sink operation and readback.

- a. Turn off the supply and connect the output as shown in Figure 2-1a, except connect a dc power supply in place of the electronic load as indicated. Set the DMM to operate in voltage mode.
- b. Set the external power supply to 5 V and a current value approximately 20% above the full scale current rating of the supply under test.
- c. Turn on the supply under test and program the output voltage to zero and full scale output current. The current on the UUT display should be approximately -1.4 A.
- d. Divide the voltage drop across the current monitoring resistor by its resistance to obtain the current sink value in amps and subtract this from the current reading on the display. The difference between the readings should be within the limits specified in the performance test record chart under CURRENT SINK READBACK.

Low Range Current Readback Accuracy

This test verifies the readback accuracy of the 20 milliampere current range.

- a. Turn off the supply and connect the output as shown in Figure 2-1b. Set the DMM to operate in current mode.
- b. Turn on the supply under test and program the output voltage to zero and full scale output current. The current on the UUT display should be approximately 0 mA.
- c. Record the current reading on the DMM and the reading on the front panel display. The difference between the two readings should be within the limits specified in the performance test record chart under 20mA RANGE CURRENT READBACK ACCURACY @ 0A.
- d. Program the output voltage to 20V and record the current reading on the DMM and the reading on the front panel display. The difference between the readings should be within the limits specified in the performance test record chart for the appropriate model under 20mA RANGE CURRENT READBACK ACCURACY @ 20mA
- e. Turn off the supply and connect the output and an external supply as shown in Figure 2-1c. Set the DMM to operate in current mode.
- f. Turn on the external supply and program it to 20 V and 1 amp. Then program the supply under test to zero volts and 1 amp. The UUT display should read approximately -20 mA.
- c. Record the current reading on the DMM and the reading on the front panel display. The difference between the two readings should be within the limits specified in the performance test record chart under 20mA RANGE CURRENT READBACK ACCURACY @ -20 mA.

CC Load and Line Regulation

These tests (CC Load Effect and CC Source Effect given below) are tests of the dc regulation of the power supply's output current. To insure that the values read are not the instantaneous measurement of the ac peaks of the output current ripple, several dc measurements should be made and the average of these readings calculated. An example of how to do this is given below using an HP 3458A System Voltmeter programmed from the front panel. Set up the voltmeter and execute the "Average Reading" program follows:

- a. Program 10 power line cycles per sample by pressing NPLC 1 0 ENTER .
- b. Program 100 samples per trigger by pressing (N Rds/Trig) 1 0 0 ENTER .

2 - Verification and Performance Tests

- c. Set up voltmeter to take measurements in the statistical mode as follows:
Press Shift key, f0, Shift key, N
Press ^ (up arrow) until MATH function is selected, then press >.
Press ^ (up arrow) until STAT function is selected then press (ENTER).
- d. Set up voltmeter to read the average of the measurements as follows:
Press Shift key, f1, Shift key, N.
Press down arrow until RMATH function is selected, then press >.
Press ^ (up arrow) until MEAN function is selected, then press ENTER.
- e. Execute the program by pressing f0, ENTER, TRIG, ENTER
- f. Wait for 100 readings and then read the average measurement by pressing f1, ENTER.

To repeat the measurement, perform steps (e) and (f).

CC Load Effect

This test measures the change in output current for a change in load from full scale output voltage to short circuit.

- a. Turn off the supply and connect the output as shown in Figure 2-1a with the DVM connected across the current monitoring resistor.
- b. Turn on the supply and program the current to the full scale current value and the output voltage to the maximum programmable voltage value.
- c. Adjust the load in the CV mode for full scale voltage as indicated on the front panel display. Check that the CC annunciator is on. If it is not, adjust the load so that the output voltage drops slightly.
- d. Record the output current reading (DVM reading/current monitor resistance value in ohms). You may want to use the average reading program described under “CC Load and Line Regulation”.
- e. Short the load switch and record the output current reading. The difference in the current readings in steps (d) and (e) is the load effect and should not exceed the limit specified in the performance test record chart for the appropriate model under CC LOAD EFFECT.

CC Source Effect

This test measures the change in output current that results when the AC line voltage changes from the minimum to the maximum value within the specifications.

- a. Turn off the supply and connect the ac power line through a variable voltage transformer.
- b. Connect the output terminals as shown in Figure 2-1a with the DVM connected across the current monitoring resistor. Set the transformer to the nominal line voltage.
- c. Turn on the supply and program the current to the full scale value and the output voltage to the maximum programmable value.
- d. Adjust the load in the CV mode for full scale voltage as indicated on the front panel display. Check that the CC annunciator is on. If it is not, adjust the load so that the output voltage drops slightly.
- e. Adjust the transformer to the lowest rated line voltage.
- f. Record the output current reading (DVM reading/current monitoring resistor in ohms). You may want to use the average reading program described under “CC Load and Line Regulation”.
- g. Adjust the transformer to the highest rated line voltage.
- h. Record the output current reading again. The difference in the current readings in steps (f) and (h) is the CC source effect and should not exceed the values listed in the performance test record card under CC SOURCE EFFECT.

CC Noise (PARD)

Periodic and random deviations (PARD) in the output combine to produce a residual ac current, as well, as an ac voltage superimposed on the dc output. Constant current (CC) PARD is specified as the rms output current in a frequency range 20 Hz to 20 Mhz with the supply in CC operation.

- a. Turn off the supply and connect the load, monitoring resistor, and rms voltmeter as shown in Figure 2-1a. The Current Monitoring resistor may have to be substituted by one with a higher resistance and power rating, such as a 1 ohm 5 W current shunt in series with a 9 ohm resistor, to get the RMS voltage drop high enough to measure with the RMS voltmeter. Leads should be as short as possible to reduce noise pick-up. An electronic load may contribute ripple to the measurement so if the RMS noise is above the specification a resistive load may have to be substituted for this test.
- b. Check the test setup for noise with the supply turned off. Other equipment (e.g. computers, DVMs, etc.) may affect the reading.
- c. Turn on the supply and program the current to full scale and the output voltage to the maximum programmable value.
- d. The output current should be at the full scale rating with the CC annunciator on.
- e. Divide the reading on the rms voltmeter by the load resistance to obtain rms current. It should not exceed the values listed in the performance test record card under CC NOISE (RMS).

Performance Test Equipment Form

Test Facility: _____	Report Number _____
_____	Date _____
_____	Customer _____
_____	Tested By _____
Model _____	Ambient Temperature (C) _____
Serial No. _____	Relative Humidity (%) _____
Options _____	Nominal Line Frequency _____
Firmware Revision _____	

Special Notes:

Test Equipment Used:

Description	Model No.	Trace No.	Cal. Due Date
AC Source	_____	_____	_____
DC Voltmeter	_____	_____	_____
RMS Voltmeter	_____	_____	_____
Oscilloscope	_____	_____	_____
Electronic Load	_____	_____	_____
Current Shunt	_____	_____	_____
	_____	_____	_____

Performance Test Record Form

Model _____	Report No _____		Date _____	
Test Description	Minimum Specs.	Results*	Maximum Specs.	Measurement Uncertainty
Constant Voltage Tests				
Voltage Programming and Readback				
Low Voltage (0V) Vout	- 10 mV	_____	+ 10 mV	1.6 μ V
Front Panel Display Readback	Vout - 3 mV	_____	Vout + 3 mV	1.6 μ V
High Voltage (Full Scale) Vout	19.980 V	_____	20.020 V	335 μ V
Front Panel Display Readback	Vout - 9 mV	_____	Vout + 9 mV	335 μ V
Load Effect	Vout - 2.0 mV	_____	Vout + 2.0mV	20 μ V
Source Effect	Vout - 0.5 mV	_____	Vout + 0.5 mV	20 μ V
PARD (Ripple and Noise)				
Peak-to-Peak	Vout - 3 mV	_____	Vout + 3 mV	872 μ V
RMS	Vout - 0.5 mV	_____	Vout + 0.5 mV	50 μ V
Transient Response				
Time in 100 μ s	Vout - 20 mV	_____	Vout + 20 mV	3 mV
Constant Current Tests				
Current Programming and Readback				
Low current (0A) Iout	- 1.0 mA	_____	+ 1.0 mA	15.2 μ A
Readback Accuracy @ Iout	Iout - 0.25 mA	_____	Iout + 0.25 mA	15.2 μ A
High Current (Full Scale) Iout	1.998 A	_____	2.002 A	252 μ A
Readback Accuracy @ Iout	Iout - 4.3 mA	_____	Iout + 4.3 mA	252 μ A
Current Sink (@ -1.4A) Readback	Iout - 3.65 mA	_____	Iout + 3.65 mA	200 μ A
20 mA Range Current Readback				
Readback Accuracy @ 0 A	- 2.5 μ A	_____	+ 2.5 μ A	0.1 μ A
Readback Accuracy @ + 20 mA	19.9775 mA	_____	20.0225 mA	1.7 μ A
Readback Accuracy @ - 20 mA	- 19.9775 mA	_____	- 20.0225 mA	1.7 μ A
PARD (Current Ripple and Noise)				
RMS	Iout - 1.0 mA	_____	Iout + 1.0 mA	200 μ A
Load Effect	Iout - 0.5 mA	_____	Iout + 0.5 mA	1.6 μ A
Source Effect	Iout - 0.5 mA	_____	Iout + 0.5 mA	1.6 μ A

* Enter your test results in this column

Troubleshooting

Introduction

WARNING: **SHOCK HAZARD.** Most of the troubleshooting procedures given in this chapter are performed with power applied and protective covers removed. Such maintenance should be performed only by service trained personnel who are aware of the hazards (for example, fire and electrical shock).

CAUTION: This instrument uses components which can either be damaged or suffer serious performance degradation as a result of ESD (electrostatic discharge). Observe the standard antistatic precautions to avoid damage to the components. An ESD summary is given in Chapter 1.

This chapter provides troubleshooting and repair information for the dc power supply. Before attempting to troubleshoot the dc power supply, first check that the problem is with the supply itself and not with an associated circuit. The verification tests in Chapter 2 enable you to isolate a problem to the dc power supply. Troubleshooting procedures are provided to isolate a problem to one of the circuit boards or a particular circuit. Figure 3-2 shows the location of the circuit boards and other major components of the unit. If a problem has been isolated to the A1 Control circuit board, additional troubleshooting procedures are available to isolate the problem to the defective component(s). Disassembly procedures are provided at the end of this chapter and should be referred to, as required, in order to gain access to and/or replace defective components.

If a component is defective, replace it and then conduct the verification test given in Chapter 2.

NOTE: Note that when certain components are replaced, the supply must be calibrated (see "Post Repair Calibration" later in this chapter). If the A2 Interface Board is replaced, the supply must be initialized before it is calibrated. See "Initialization" later in this chapter.

Chapter 5 lists all of the replaceable parts for the power supplies. Chapter 6 contains schematics, test point measurements, and component location diagrams to aid you in troubleshooting the supply.

Test Equipment Required

Table 3-1 lists the test equipment required to troubleshoot the power supply. Recommended models are listed.

Table 3-1. Test Equipment Required for Troubleshooting

Type	Purpose	Recommended Model
HP-IB Controller	To communicate with the supply via the HP-IB interface	HP Series 200/300
Digital Voltmeter	To check various voltage levels	HP 3458A
Oscilloscope	To check waveforms and signal levels	HP 54504A/54111A
Electronic Load	To test operation of current circuit	HP 6060B
IC Test Clips	To access IC pins	AP Products No. LTC
Ammeter/Current Shunt	To measure output current	Guildline 9230/15

Overall Troubleshooting

Overall troubleshooting procedures for the power supply are given in the figure 3-1. The procedures first check that neither an AC input, nor a bias supply failure is causing the problem and that the supply passes the turn-on self test (error annunciator stays off). The normal turn-on, self-test indications are described in the "Checkout Procedure" in Chapter 3 of the User's Guide.

If the supply passes the self test and there are no obvious faults, you should perform the verification procedures in Chapter 2 from the front panel to determine if any functions are not calibrated or are not operating properly. Then program and read back a voltage via the HP-IB to see if the supply responds properly to bus commands. If the supply fails any of the tests, you will be directed to the applicable flow chart or troubleshooting procedure.

Flow Charts

Troubleshooting flow charts are given in figure 3-1 sheets 1-13. Several flow charts make reference to the test points listed in Chapter 6. The circuit locations of the test points are shown on the schematics and on the component location diagrams in Chapter 6.

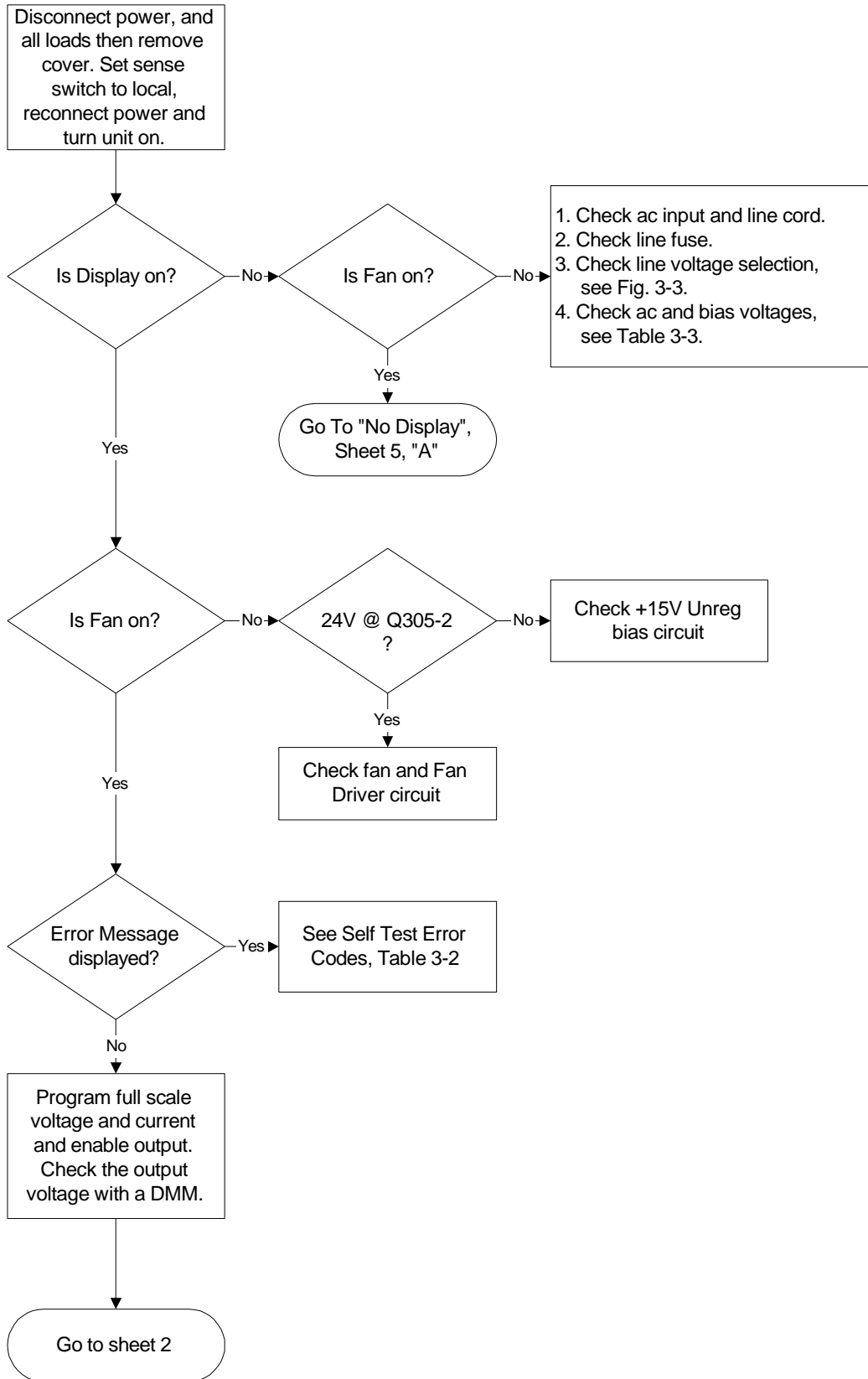

Figure 3-1 Sheet 1. Main Flowchart

3 - Troubleshooting

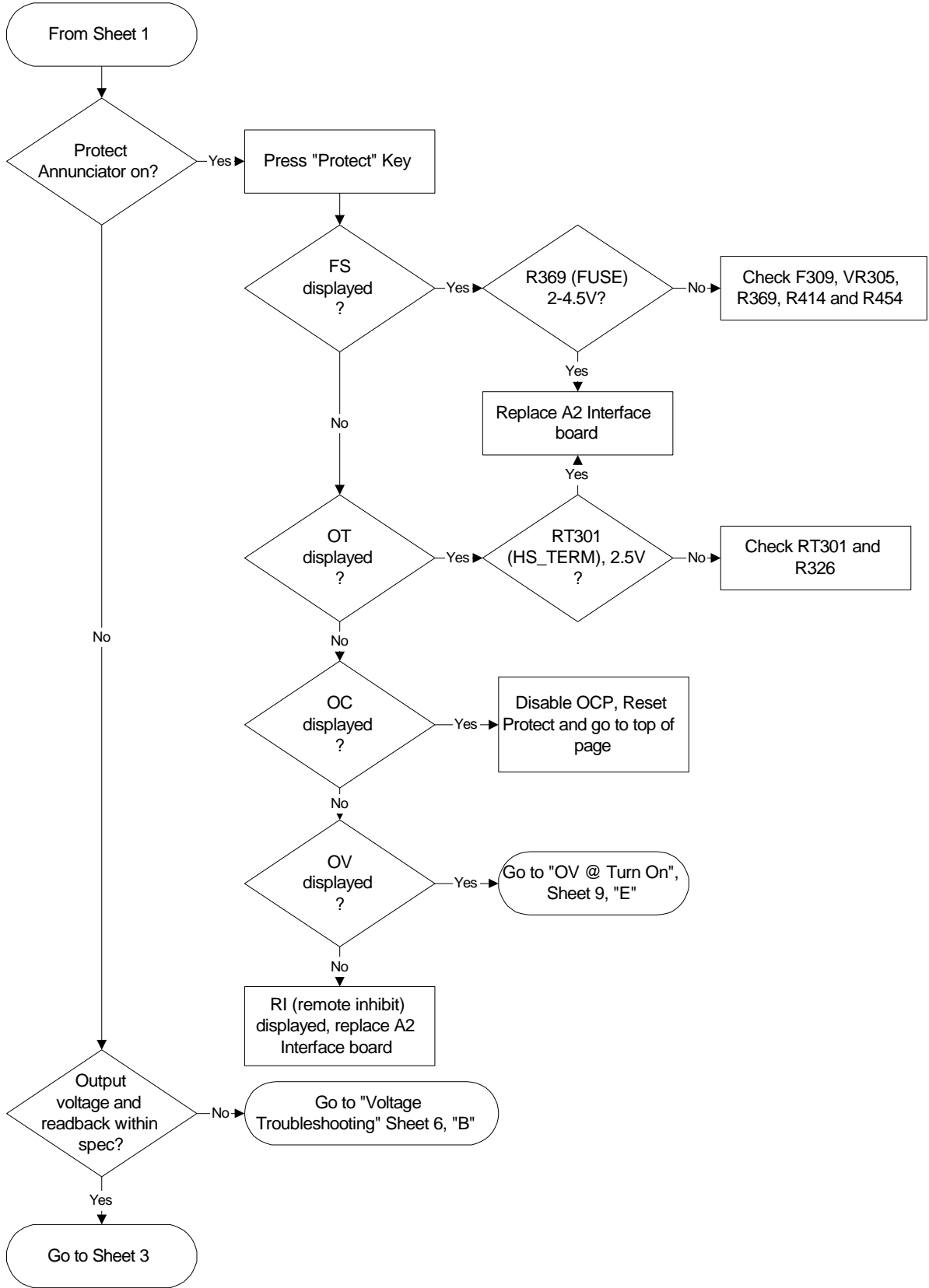

Figure 3-1 Sheet 2. Main Flowchart

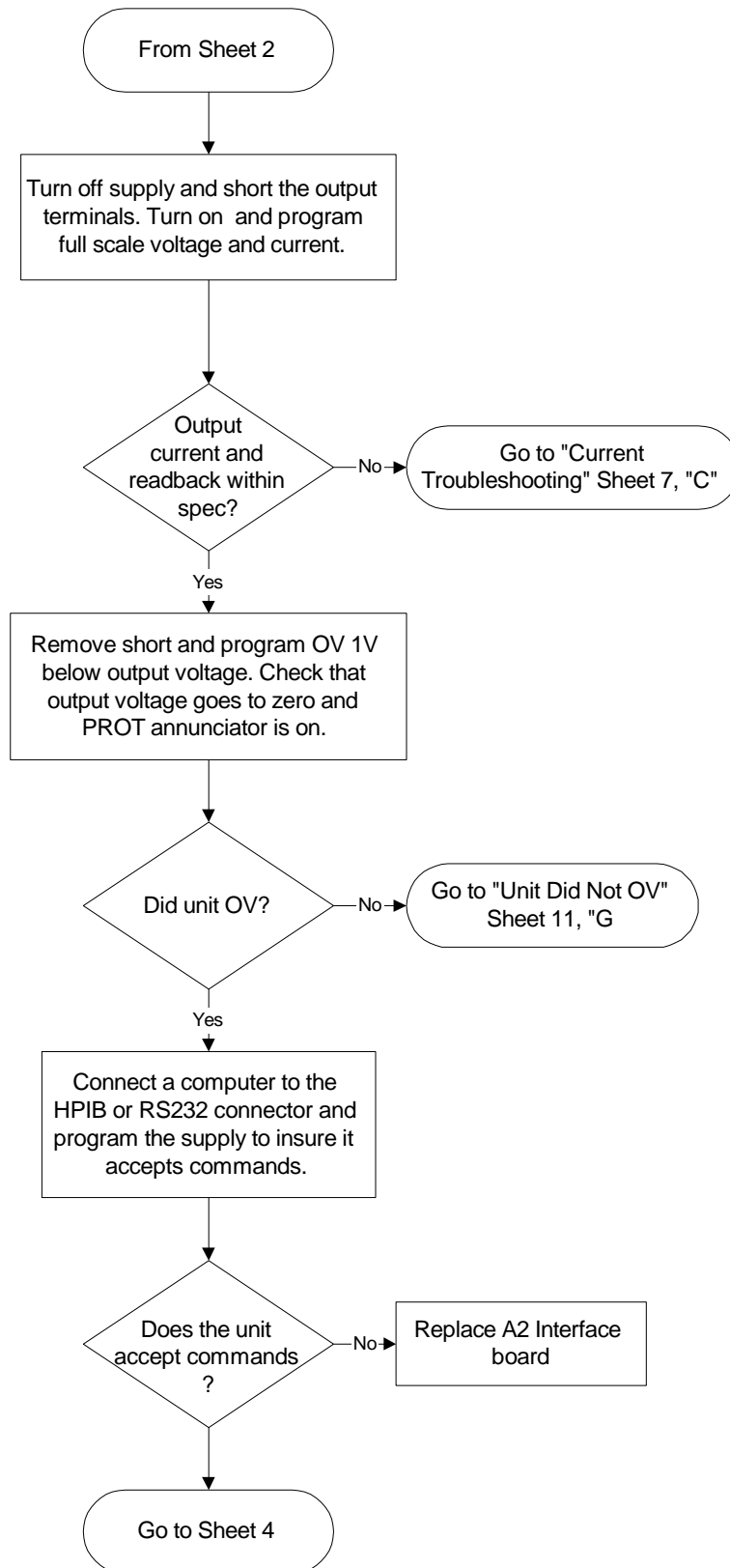

Figure 3-1 Sheet 3. Main Flowchart

3 - Troubleshooting

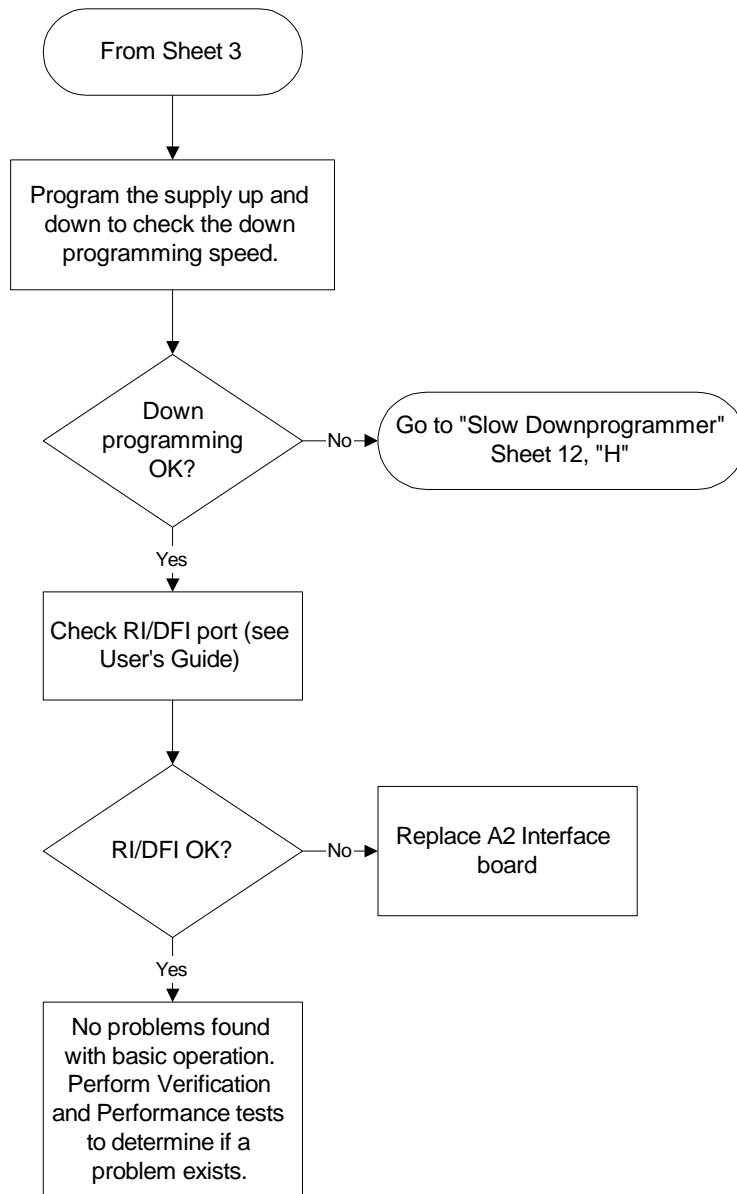

Figure 3-1 Sheet 4. Main Flowchart

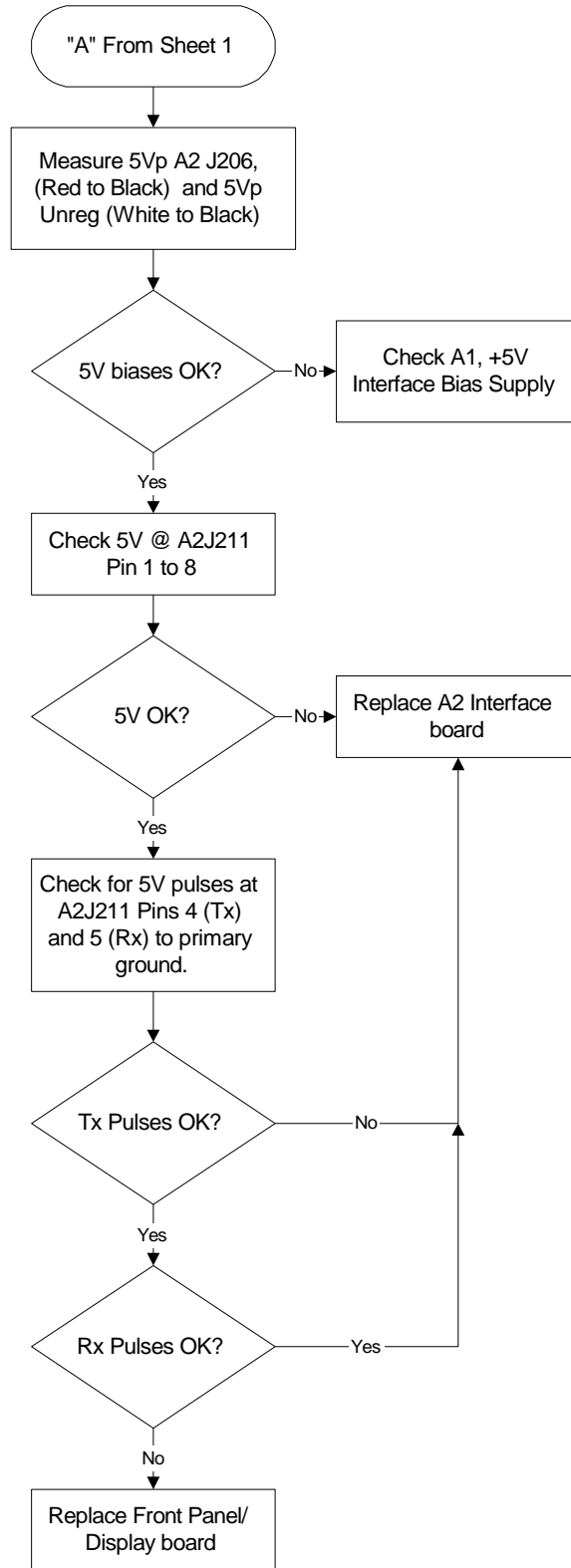

Figure 3-1 Sheet 5. No Display

3 - Troubleshooting

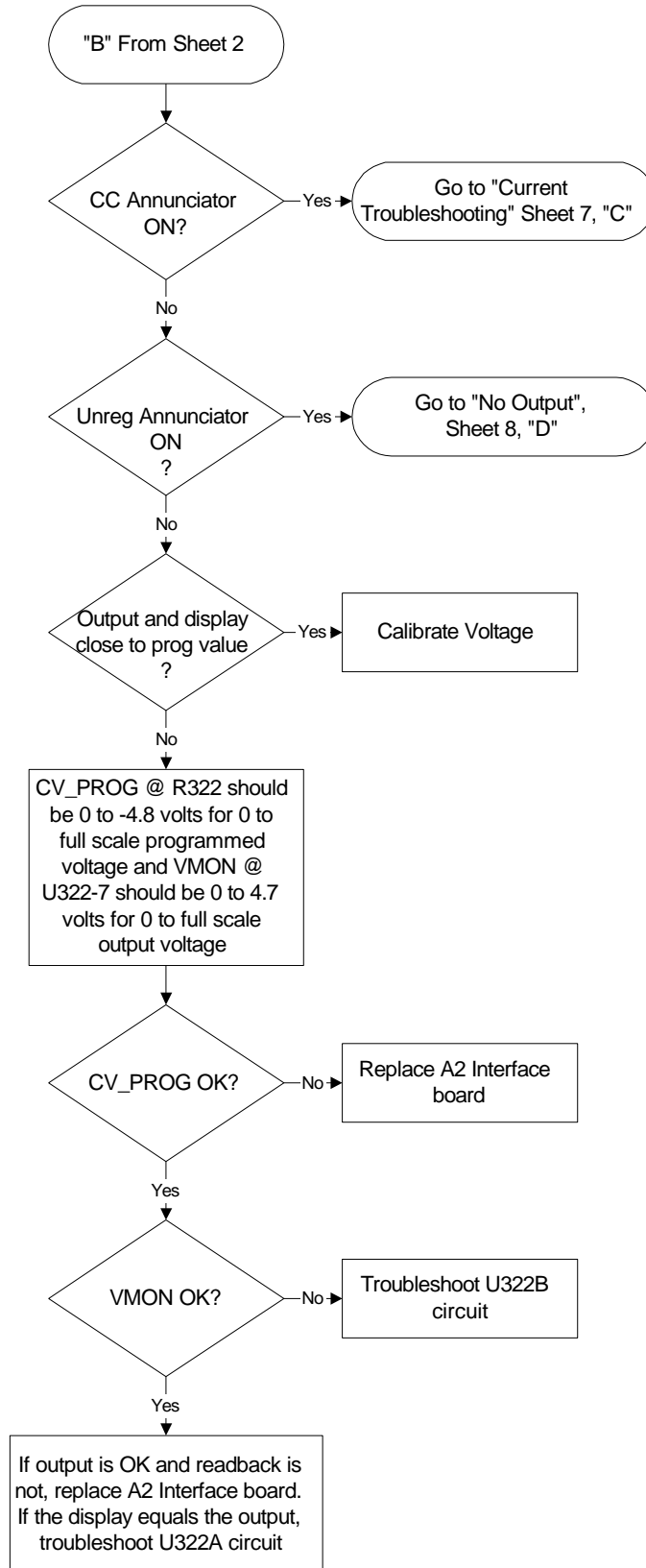

Figure 3-1 Sheet 6. Voltage Troubleshooting

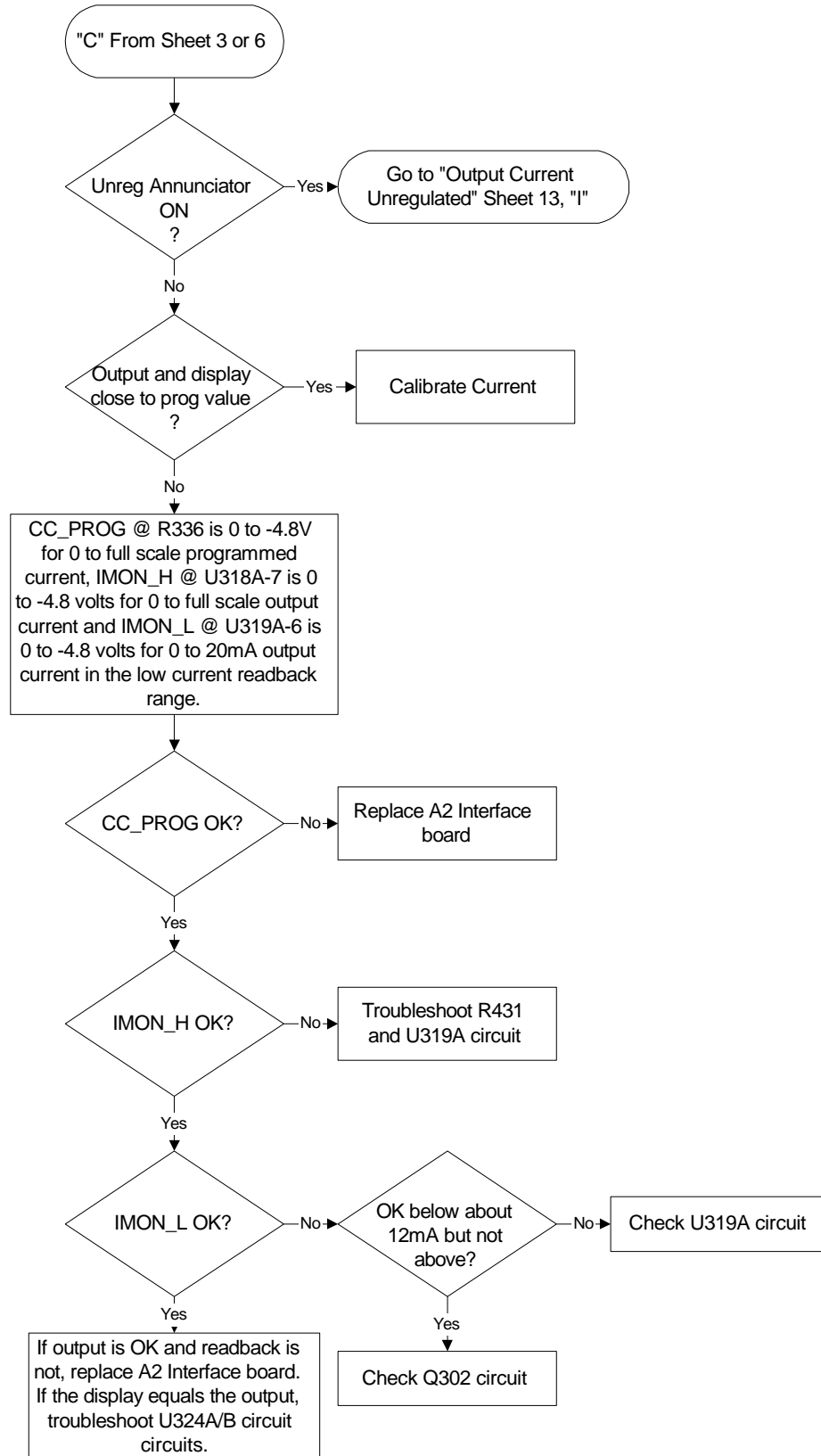

Figure 3-1 Sheet 7. Current Troubleshooting

3 - Troubleshooting

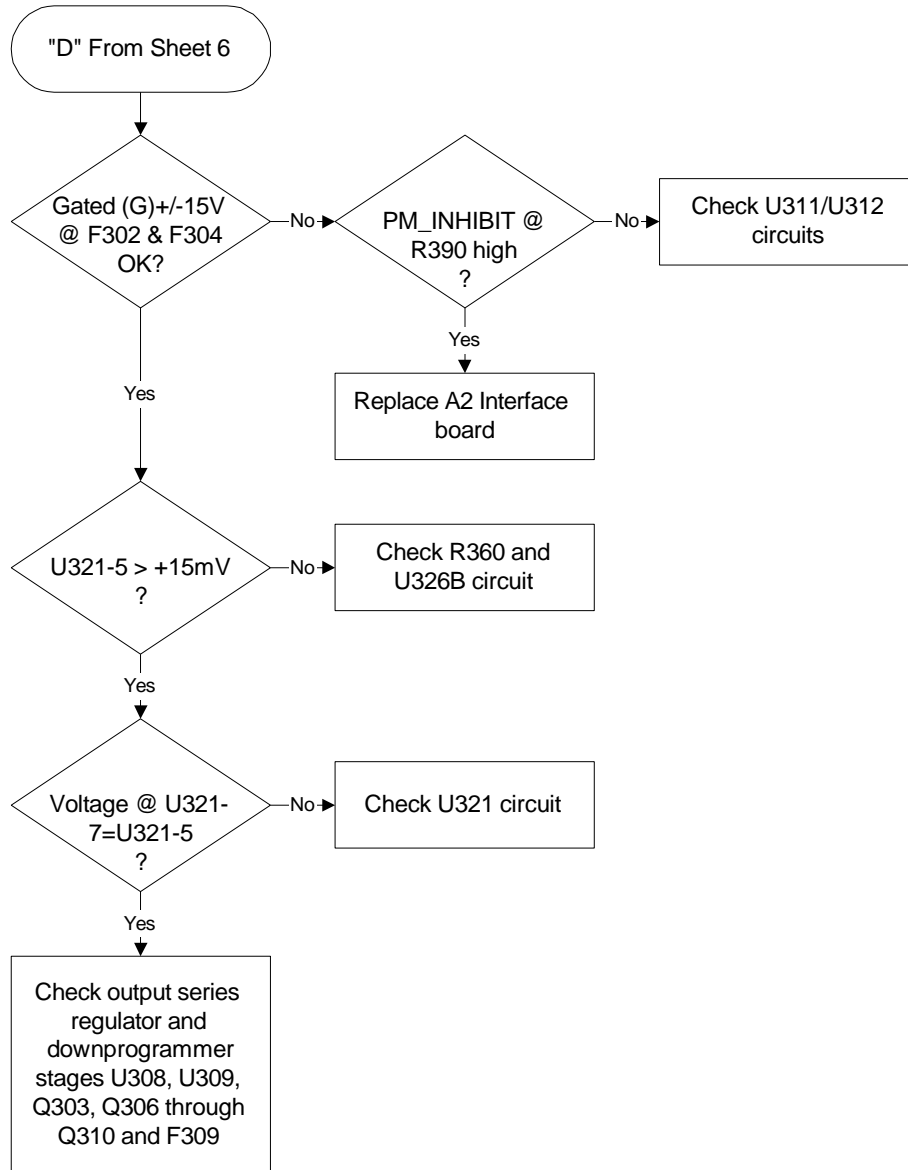

Figure 3-1 Sheet 8. No Output

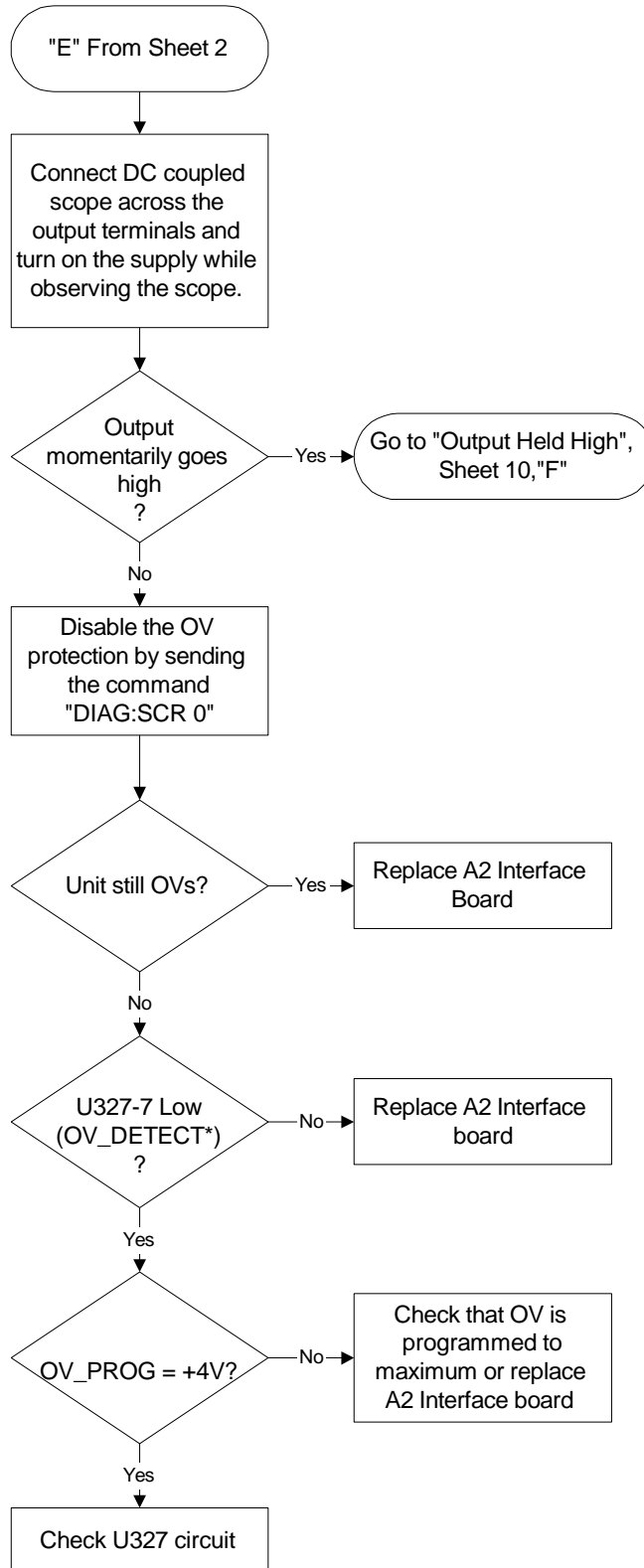

Figure 3-1 Sheet 9. Overvoltage at Turn-On

3 - Troubleshooting

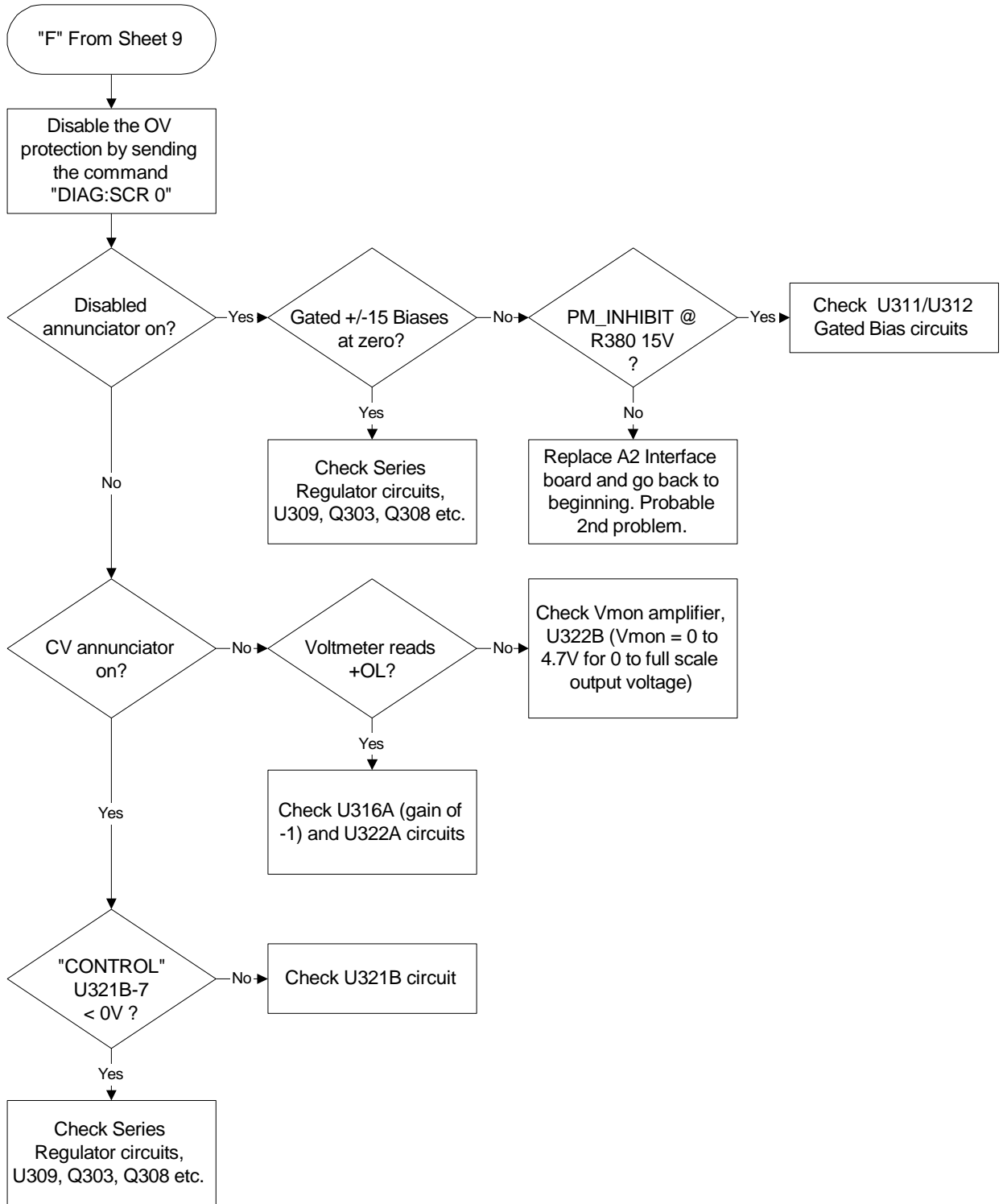

Figure 3-1 Sheet 10. Output Held High

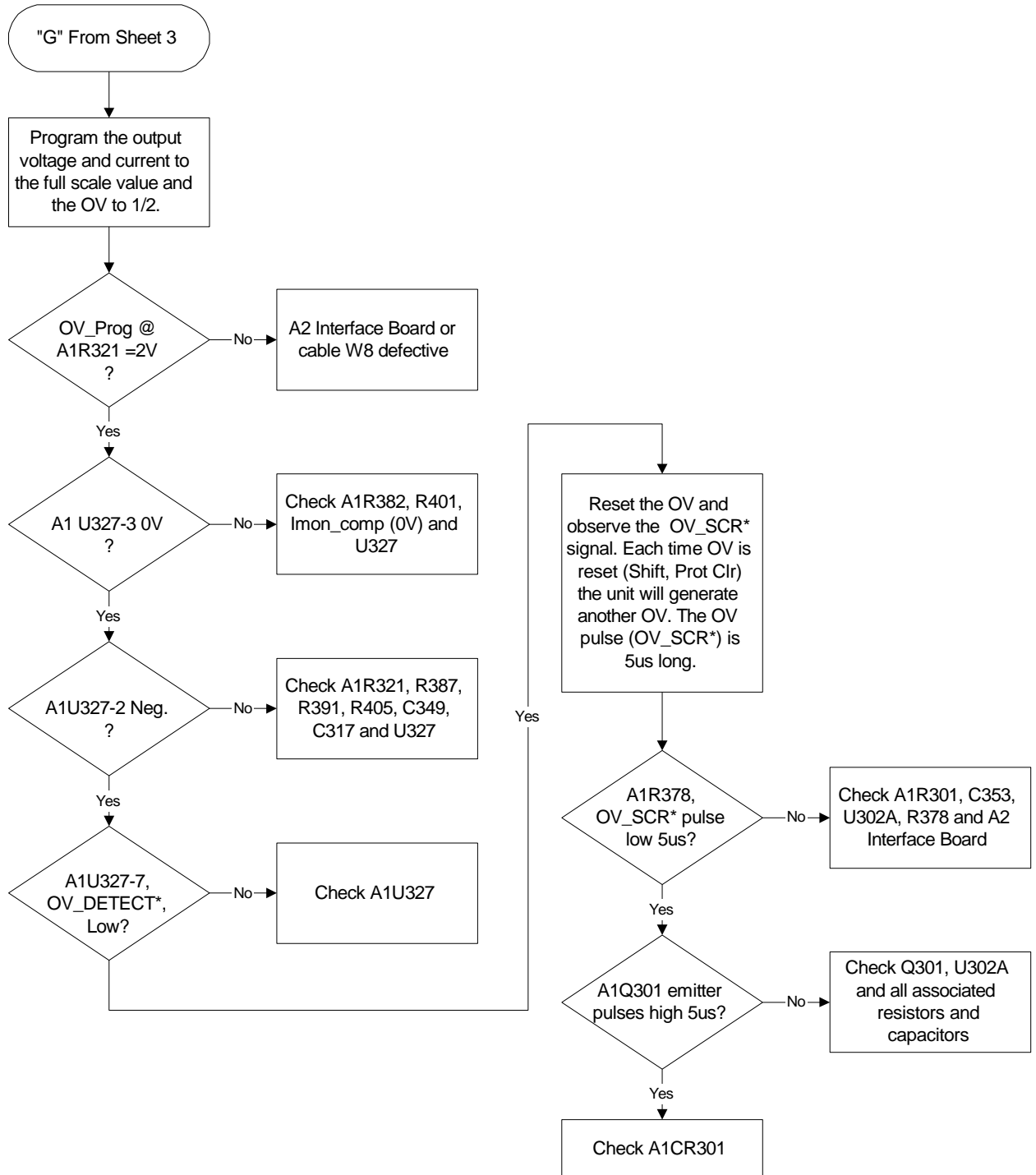

Figure 3-1 Sheet 11. Unit Did Not Overvoltage

3 - Troubleshooting

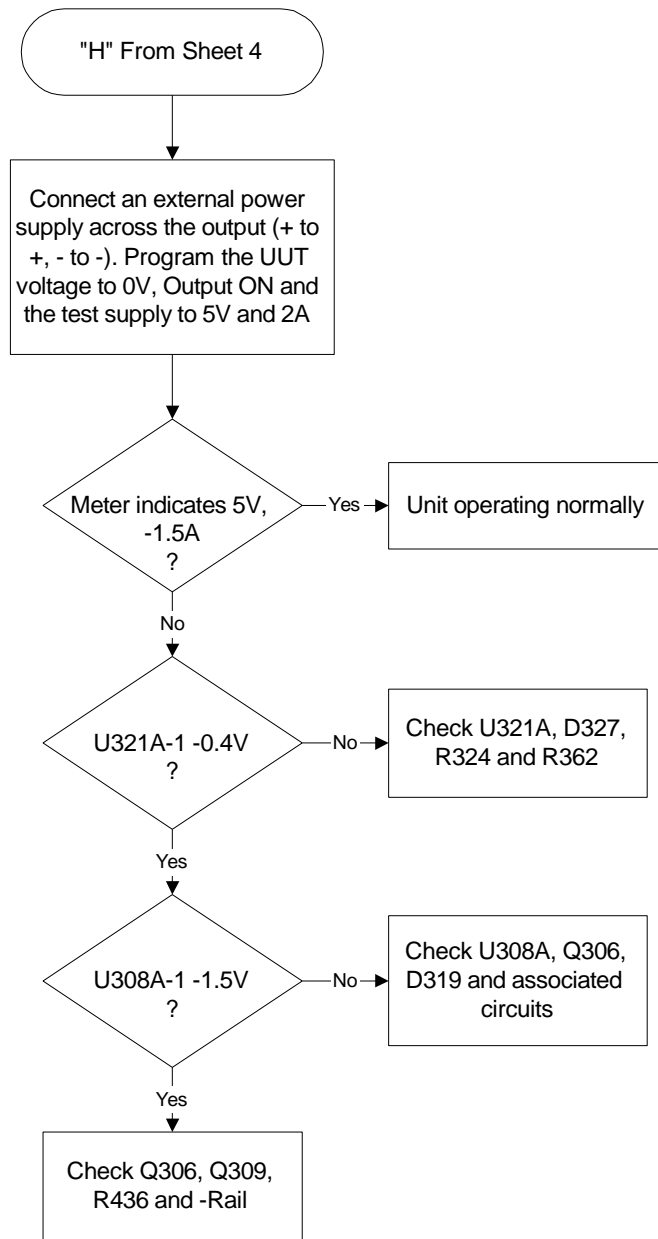

Figure 3-1 Sheet 12. Slow Dwnprogrammer

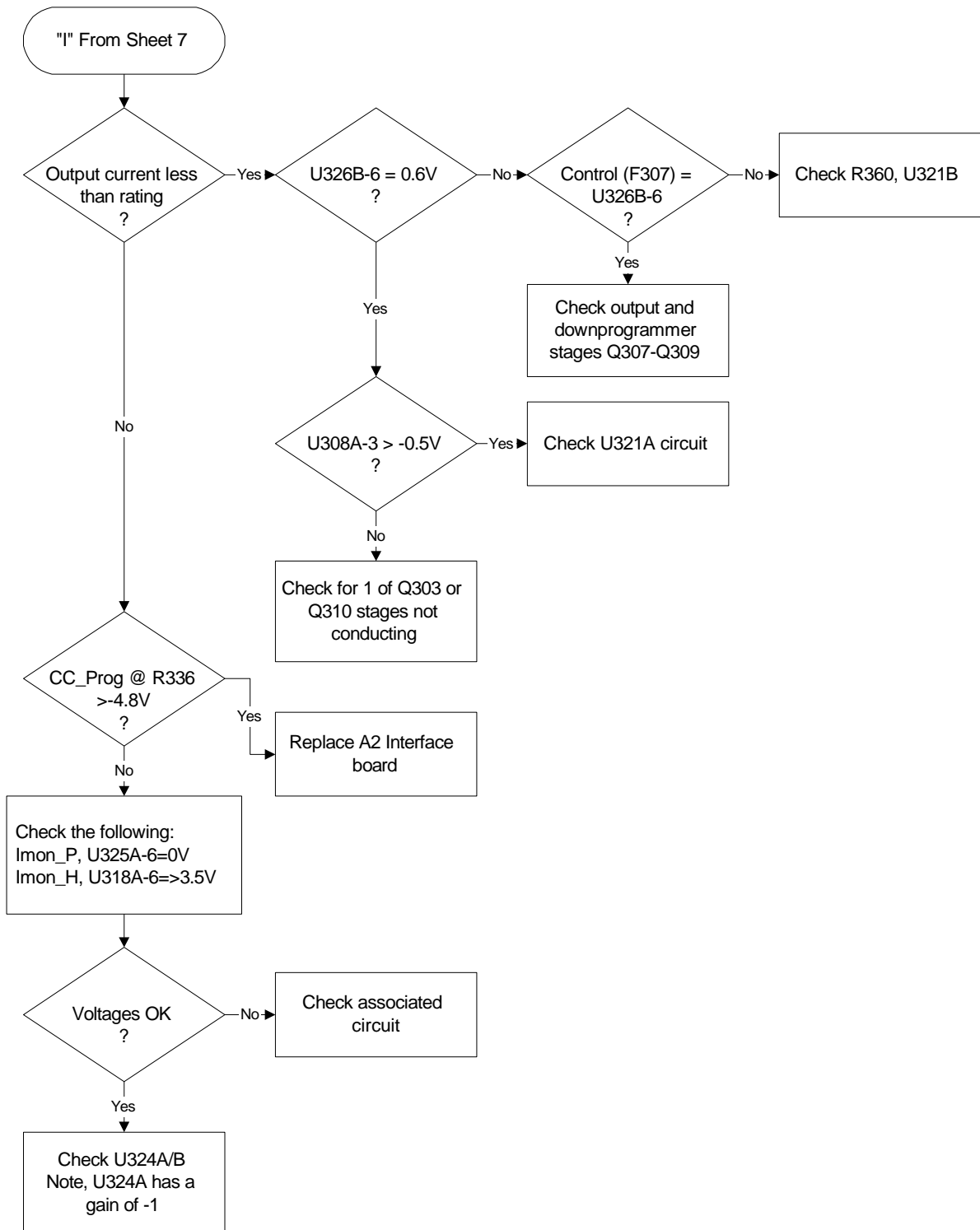

Figure 3-1 Sheet 13. Current at Maximum

Specific Troubleshooting Procedures

Power-on Self-test Failures

The power-on self-test sequence tests of most of the digital and DAC circuits. If the supply fails self-test, the display "ERR" annunciator will come on. You can then query the unit to find out what the error(s) are. When an error is detected, the output is not disabled so you can still attempt to program the supply to help troubleshoot the unit. Table 3-2 lists the self test errors and gives the probable cause for each error.

NOTE: A partial self test is performed when the *TST? query is executed. Those tests that interfere with normal interface operation or cause the output to change are not performed by *TST?. The return value of *TST? will be zero if all tests pass, or the error code of the first test that failed. The power supply will continue normal operation if *TST? returns a non-zero value.

Table 3-2. Self-Test Error Codes/Messages

Error Code	Description	Probable Cause
E1	Checksum in Read-only Non-volatile ROM	A2 Interface Bd
E2	Checksum in Config Non-volatile ROM	A2 Interface Bd
E3	Checksum in Cal Non-volatile ROM	A2 Interface Bd
E4	Checksum in State Non-volatile ROM	A2 Interface Bd
E5	Checksum in RST Non-volatile ROM	A2 Interface Bd
E10	RAM test failed	A2 Interface Bd
E11	12 bit DAC test failed, 0 is written to DAC U241A and B, ADC U242 is checked for 133 +/- 7 counts	A2 Interface Bd
E12	12 bit DAC test failed, 4095 is written to DAC U241A and 0 to B, ADC U242 is checked for 71 +/- 7 counts	A2 Interface Bd
E13	12 bit DAC test failed, 0 is written to DAC U241A and 4095 to B, ADC U242 is checked for 71 +/- 7 counts	A2 Interface Bd
E14	12 bit DAC test failed, 4095 is written to DAC U241A and B, ADC U242 is checked for 10 +/- 7 counts	A2 Interface Bd
E15	8 bit DAC test failed, 10 and 240 are written to DAC U244, ADC U242 is checked for 10 and 240 +/- 7 counts	A2 Interface Bd
E80	Dig I/O test failed, SEC_PCLR written low and high, read back through Xilinx	A2 Interface Bd
E213	RS-232 input buffer overrun	A2 Interface Bd
E216	RS-232 framing error	A2 Interface Bd
E217	RS-232 parity error	A2 Interface Bd
E218	RS-232 UART input overrun	A2 Interface Bd
E220	Front Panel comm UART input overrun	A3 Front Panel/Display Bd
E221	Front Panel comm UART framing error	A3 Front Panel/Display Bd
E222	Front Panel comm UART parity error	A3 Front Panel/Display Bd
E223	Front Panel firmware input buffer overrun	A3 Front Panel/Display Bd

CV/CC Status Annunciators Troubleshooting

The CV/CC annunciators are particularly helpful when troubleshooting a unit with no output. If the unit has no output voltage or current and one of the annunciators is on then the problem is in the control circuit associated with that annunciator. An example of how this might be useful would be in a case where the voltage and current are programmed to some positive value, there is no output voltage and the CV annunciator is on. This indicates that the problem is probably in the Voltage Amplifier circuit. If the CC annunciator were on then the problem would likely be in the Current Amplifier. If UNR is indicated then neither the voltage nor the current circuits are in control and the problem would be in circuits after the gating diodes such as the driver or output regulator stages.

When troubleshooting the CV/CC status annunciators or the status readback circuits, first measure the voltage drop across the gating diodes; A1 D317 (CV) and D321 (CC). A conducting diode indicates an active (ON) control circuit. This forward drop is applied to the input of the associated status comparator (U328C and D respectively) and drives the output (CV_DETECT* or CC_DETECT*) low. The low signal indicates an active status which is sent to the A2 board microprocessor. The front panel CV annunciator indicates when the CV mode is active (CV_DETECT* is low). The front panel CC annunciator indicates when the CC mode is active (CC_DETECT* is low). The UNREGULATED (UNR) annunciator comes on when neither the CV nor CC is active.

Bias and Reference Supplies

Before troubleshooting any circuit check the bias and/or reference voltages to make sure that they are not the cause. Table 3-3 lists the bias and reference voltage test points for the A1 Main Control , A2 Interface, and the A3 Front Panel/Display boards. Unless otherwise noted, all voltages are measured with respect to secondary common (R431-3) with no load on the supply.

Table 3-3. Bias and Reference Voltages

Bias	Test Point	Common	Measurement
+5V primary	A1 J206-1(Red)	Chassis (J206-2 black)	+5V +/- 0.15V
+5V secondary	A1 R423	Secondary Common	+5V +/- 0.2V
+15V secondary	A1 R419	Secondary Common	+15V +/- 0.6V
-15V secondary	A1 R422	Secondary Common	-15V +/- 0.6V
+15V secondary gated	A1 F304	Secondary Common	+14.2V +/- 5%
-15V secondary gated	A1 F302	Secondary Common	-14.2V +/- 5%
+Rail ¹	A1 D311 cathode	- Output	+32V +/- 10% (100mV P/P)
-Rail ¹	A1 D307 Anode	Secondary Common	-6.5V +/- 10% (100mV P/P)
+2.5V reference ²	A1 J307-6	Secondary Common	+2.5V +/- 5%

¹ Measured with respect to - Output at nominal ac input line voltage

² the 2.5V reference originates on the A2 Interface board

3 - Troubleshooting

J307 Voltage Measurements

J307 connects the A1 Main Board Assembly to the A2 Interface Assembly. Table 3-4 provides a quick method of determining if the voltages between these assemblies are within the normal range. If any of these voltages is outside the normal range, refer to the flowcharts to further troubleshoot the circuit associated with the abnormal voltage.

Table 3-4. Voltage Measurements at J307 (A2 Interface to A1 Main board)

A1J307 Pin #	Signal Name	CV Mode Full Scale Voltage No Load	CC Mode Full Scale Voltage Full Load
1	PM_INHIBIT (Enabled)	0	0
2	OV_SCR*	+5	+5
3	OV_PROG	+3.9	+3.9
4	FAN_PROG	+2.8	+3.8
5	OV_DETECT*	+5	+5
6	SW_POS (Norm)	+5	+5
7	RANGE_SELECT (High)	0	0
8	OS_TRIM_NEG (COMP)	+1.7	+1.7
	OS_TRIM_NEG (SCPI)	+4.0	+4.0
9	+5Vs	+5	+5
10	COMMON	0	0
11	COMMON	0	0
12	+15Vs	+15	+15
13	-15Vs	-15	-15
14	HS_THERM (@25C)	+2.5	+2.5
15	FUSE	+2.4	+2.6
16	IMON_H	0	+3.5
17	IMON_L	0	+14.7
	IMON_L (@20mA Out)	+4.8	+4.8
18	IMON_P	0	0
19	VMON	+4.8	+4.8
20	COMMON	0	0
21	COMMON	0	0
22	COMMON	0	0
23	COMMON	0	0
24	CV_PROG	-4.8	-4.8
25	CC_PROG	-4.8	-4.8
26	CC_DETECT*	+5	0
27	CCN_DETECT*	+5	+5
28	CV_DETECT*	0	+5

Manual Fan Speed Control

Under some circumstances such as testing acoustical devices where the fan noise would interfere with the test, it would be advantageous to reduce the fan speed. If the test requires a very light load, the ambient temperature is low and the duration of the test is short, the fan speed may be temporarily reduced. The turn-on default is "Automatic" so this procedure must be performed, as needed, every time the line voltage is turned on. To manually control the fan speed:

- a. Simultaneously depress the "0" and "1" keys. EEINIT <model> will be displayed.
- b. Using the Up/Down annunciator keys select FAN:MODE<AUTO.>.
- c. Using the Up/Down arrows select FAN:MODE <MAN>
- d. Press "Enter"
- e. Simultaneously depress the "0" and "1" keys. EEINIT <model> will be displayed.
- f. Using the Up/Down annunciator keys select FAN:SPEED <data>
- g. Press "Enter Number".
- h. Enter the desired speed (numeric entry range is 0 to 100%)
- i. Press "Enter"

Disabling Protection Features

The power supply's protection features may be disabled. This is not recommended as a normal operating condition but is helpful under some circumstances such as troubleshooting. The turn-on default is "NO-PROTECT OFF" (protection enabled) so this procedure must be performed, as needed, every time the line voltage is turned on. To disable the protection:

- a. Simultaneously depress the "0" and "1" keys. EEINIT <model> will be displayed.
- b. Using the Up/Down annunciator keys select NO-PROTECT <OFF>.
- c. Using the Up/Down arrows select NO-PROTECT <ON>.
- d. Press "Enter"

Post-repair Calibration

Calibration is required annually and whenever certain components are replaced. If components in any of the circuits listed below are replaced, the supply must be re-calibrated as described in Appendix B of the User's Guide.

- a. A1 Control Board: Voltage or Current Monitor Amplifier circuits, High Bandwidth Current Amplifier, or Current Monitor resistors R425/R431
- b. A2 Interface Board

If the Interface board A2 is replaced, the supply must be initialized first (see "Initialization" later in this chapter) and then be calibrated.

Inhibit Calibration Switch

If "CAL DENIED" appears on the display when calibration is attempted, or if error code 401 occurs when calibrating over the HP-IB, the internal INHIBIT CAL switch has been set. This switch setting prevents unauthorized or inadvertent power supply calibration. You must reset this switch in order to calibrate the supply.

This four-section switch, S201, is located on the A2 Interface board near the HP-IB connector. The switch has 2 functions related to calibration. One is Inhibit Calibration. With this switch set the supply will not respond to calibration commands, thus providing security against unauthorized calibration. The other switch allows you to bypass the password in case it is forgotten.

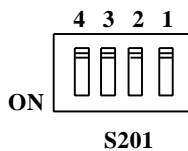

	Switch 3	Switch 4
Normal	Off	Off
Clear Password	Off	On
Inhibit Calibration	On	Off

Calibration Password

In order to enter the calibration mode, you must use the correct password as described in Appendix B of the Operating Manual. As shipped from the factory, the number 0 (zero) is the password. If you use an incorrect password, "OUT OF RANGE" will appear on the display for front panel calibration (or error code 402 occurs for HP-IB calibration) and the calibration mode will not be enabled.

If you have changed the password and have forgotten it, you can set the configuration switch on A2 Interface board to bypass the password. See "Calibration Switch" paragraph above.

Initialization

The dc power supply's HP-IB address and model number as well as other constants which are required to program and calibrate the supply are stored in a EEPROM on the A2 Interface board. The Interface board also contains references and other components that will affect the alignment of the supply. If the Interface board is replaced, the supply must be reinitialized and calibrated. To initialize the power supply:

- a. Enable the Calibration mode
- b. Simultaneously depress the "0" and "1" keys.
- c. Using the Up/Down arrows select the appropriate model number
- d. Press "Enter"

The dc power supply will go through the turn-on self test sequence. It is now re-initialized and must be calibrated. See Appendix A of the User's Guide for the calibration procedure.

ROM Upgrade

Identifying the Firmware

You can use the *IDN? query to identify the revision of the supply's firmware. The query will readback the revisions of the Primary Interface ROM located on the A2 Interface board. The manufacturer and model number of the supply are also returned. The following is a sample program:

```
10 ALLOCATE L$(42)
20 OUTPUT 705;"*IDN  ?"
30 ENTER 705;L$
40 DISP L$
50 END
```

The computer will display the manufacturer's name, the model number, a "0," and then the firmware revision. Example: "HEWLETT-PACKARD,66312A,0,A.00.01". The revision level of the ROM can also be found on the label affixed to the physical IC chip itself.

Upgrade Procedure

If the Interface board ROM is upgraded you can re-initialize the supply without affecting the calibration.

- a. Enable the Calibration mode.
- b. Simultaneously depress the "0" and "1" keys. EEINIT <model> will be displayed.
- c. Using the Up/Down annunciator keys select ROMUPD <model>.
- d. Using the Up/Down arrows select the appropriate model number.
- e. Press "Enter".

The supply will go through the turn-on self test sequence and return to the power supply metering mode.

Disassembly Procedures

The following paragraphs provide instructions on how to disassemble various components of the dc power supply. Once disassembled, the components can be reassembled by performing the disassembly instructions in reverse order. Figure 3-2 shows the location of the major components of the unit.

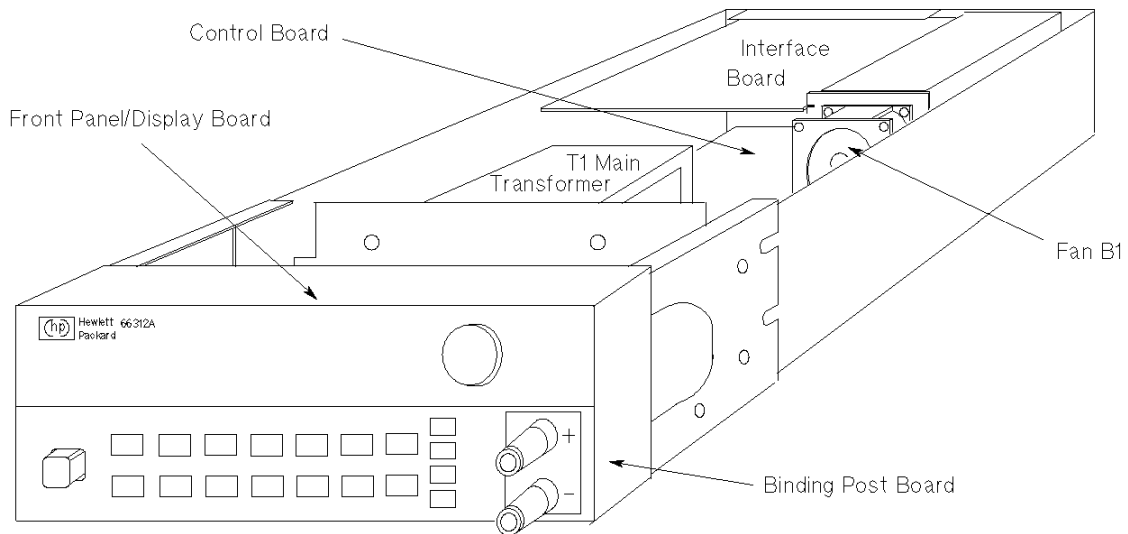

Figure 3-2. Component Location

WARNING: **SHOCK HAZARD.** To avoid the possibility of personal injury, turn off AC power and disconnect the line cord before removing the top cover. Disconnect the HP-IB cable and any loads, and remote sense leads before attempting disassembly.

CAUTION: Most of the attaching hardware is metric. Use of other types of fasteners will damage threaded inserts. Refer to the list of required tools when performing disassembly and replacement.

List of Required Tools

- a. 2PT Pozidriv screwdrivers.
- b. T10 and T15 Torx screwdrivers.
- c. Hex drivers: 7 mm for HP-IB connector,
3/16" for RS-232 connector,
1/4" for front panel binding posts
- d. Long nose pliers.
- e. Antistatic wrist discharge strap.

Cover, Removal and Replacement

- a. Using a T15 Torx screwdriver, unscrew the two captive screws which hold the rear bezel to the dc power supply, and then remove the two screws from the bottom of the case.
- b. Slide the cover backward until it clears the rear of the power supply.

A2 Interface Board, Removal and Replacement

To remove the Interface Board, proceed as follows:

- a. Remove the cover of the power supply as described under, "Cover Removal and Replacement."
- b. Remove the two 7 mm and 3/16 inch hex screws that hold the HP-IB and RS-232 connectors in place.
- c. Slide the board forward until the notch on the right side of the Interface board aligns with the fan spacer board. Rotate the right side up slightly to disengage the board from the slot in the left side of the chassis.
- d. Unplug the cable from J206. Depress the release button located at the end of the connector where the wires enter the housing.
- e. Unplug the flat cables. Note the position of the conductive side for reinstallation. Connectors release the cable by pulling out end tabs as shown by the arrows in the following figure.

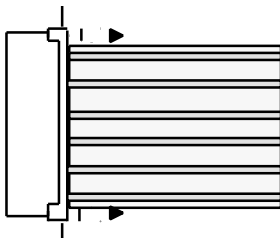

- f. To reinstall the Interface board, perform the above steps in reverse order.

Front Panel Assembly, Removal and Replacement

This procedure removes the front panel assembly from the dc power supply.

- a. Remove the Power Supply Cover as described earlier in, "Top Cover Removal and Replacement."
- b. Disconnect the cable between the Front Panel board and the Interface board at the Interface board. You may have to remove the Interface board as described above to accomplish this.
- c. Using a Torx T10 driver remove the three screws from each side of the supply that hold the front panel brackets to the chassis.
- d. Slide the Front Panel assembly forward slightly to unplug the Binding Post connector and with a Torx T15 driver remove the screw connecting the ground wire to the chassis.
- e. To remove the left bracket, locate and carefully peel off the left vinyl trim to gain access to the side screw that secures the front panel bracket to the chassis. Using a Torx T15 driver remove the screw located behind the vinyl trim.
- f. To remove the right bracket, depress the plastic tab located behind the front panel in the upper right corner.
- g. To reinstall the Front Panel Assembly, perform the above steps in reverse order.

3 - Troubleshooting

A3 Front Panel Board, Removal and Replacement

First remove the front panel assembly as described under, "Front Panel Assembly, Removal and Replacement." Once you have access to the front panel board perform these steps:

- a. Remove the RPG knob by pulling it away from the front panel.
- b. Pull back the right side of the board near the RPG about 1/8th of an inch. Slide the board to the left to disengage the holding clips.
- c. To reinstall the Front Panel board, perform the above steps in reverse order.

A1 Main Control Board

- a. Remove the top cover and the A2 Interface board as described above.
- b. Disconnect all cables going to connectors on the main control board.

NOTE: Be sure to note the position and orientation of all cables prior to removal so that no mistake is made later when reinstalling these cables.

- c. Disconnect the ground wire between the main board and the chassis. This wire is secured to the side of the chassis near the AC input by a Torx T10 screw.
- d. Remove three Torx T15 screws which secure the main control board to the chassis.
- e. Slide the main board towards the front panel to release it from chassis mounted standoffs and then lift the board out of the chassis.

T1 Power Transformer, Removal and Replacement

To remove the power transformer, the front panel assembly must first be removed to gain access to the bracket screws that hold the transformer in place.

- a. Remove the front panel assembly as described above.
- b. Remove the two Torx T10 screws securing the rear of the transformer bracket to the bottom of the chassis and the two screws securing the front of the bracket.
- c. Use long nose pliers to disconnect all wires going to the transformer terminals.
- d. Lift the transformer out of the chassis.

NOTE: The AC power connections at the transformer primary are line voltage dependent. Refer to Figure 3-3 subsequent reconnection.

Line Voltage Wiring

Figure 3-3 illustrates the primary wiring configuration of the power transformer for various ac line voltages. Use long nose pliers to disconnect the wires going to the transformer terminals.

NOTE: Install the correct fuse when changing the ac line voltage from a previous setting:
for 110/120 Vac: 2 A, HP p/n 2110-0002;
for 220/230 Vac: 1 AT, HP p/n 2110-0007

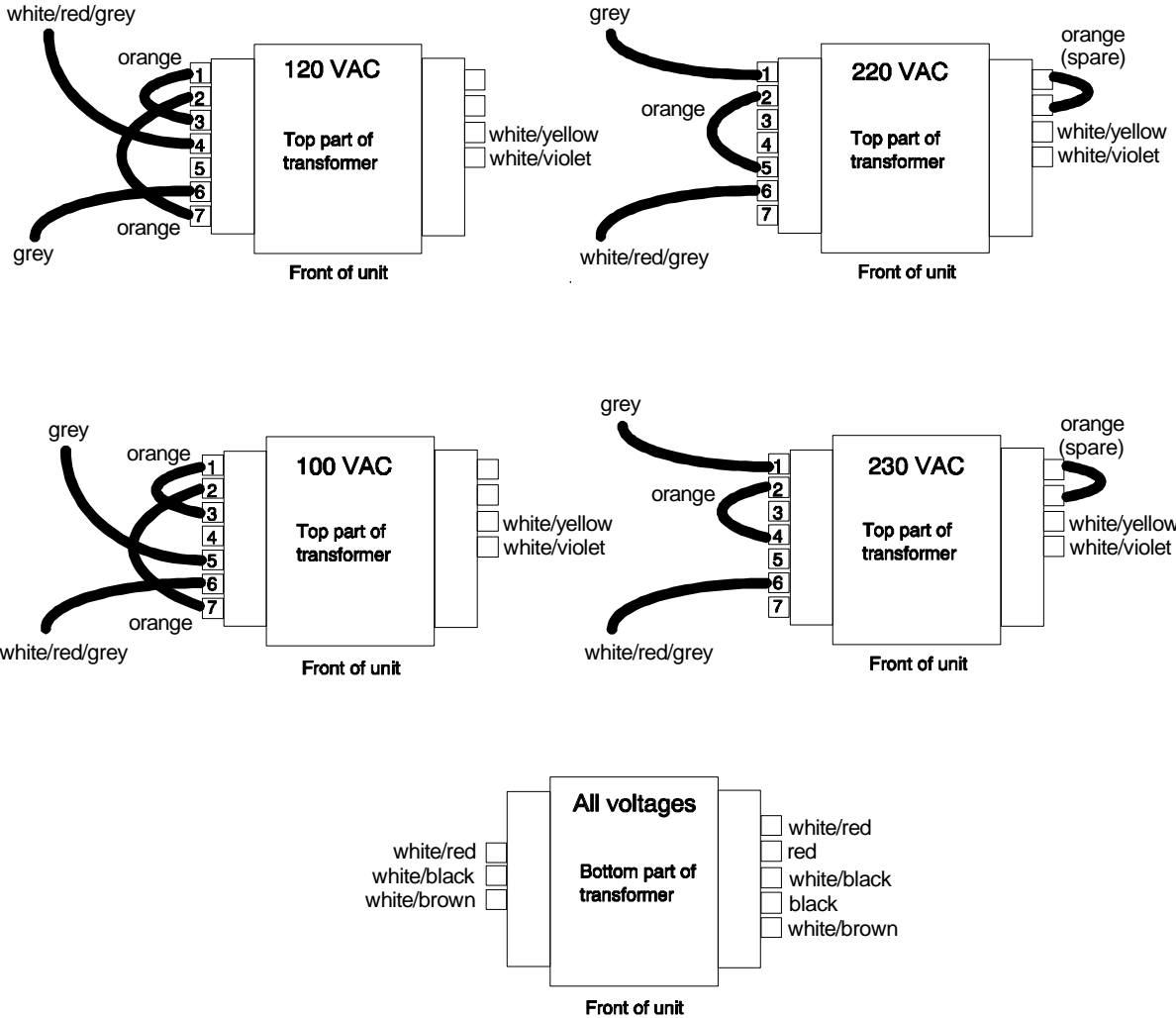

Figure 3-3. Transformer Wiring

Principles of Operation

Introduction

This section describes the different functional circuits used in the dc power supply models covered in this manual. First, the I/O external signals that connect to the HP power supply are described. Next, the overall block diagrams for the dc power supply are described in detail.

The simplified block diagrams in this section show the major circuits on the dc power supply as well as the signals between circuits. They also show the reference designations of some of the components in the functional circuit. These same reference designators are shown in the schematic diagrams in Section 6.

I/O Interface Signals

Table 4-1 describes the interface signals between the power supply and the end user (or other external circuits and devices).

Table 4-1. Power Supply Interface signals

Connector	Signal	Description										
Front panel outputs	+OUT -OUT	Positive DC output voltage Negative DC voltage (or return)										
Rear panel output/sense screw terminals	+OUT -OUT + sense - sense common	Positive DC output voltage Negative DC voltage (or return) +OUT sensing terminal ¹ -OUT sensing terminal ¹ connected to ground conductor ¹ Set SENSE switch to "Remote" when using the sensing terminals.										
INH/FLT connector	pin 1 pin 2 pin 3 pin 4	<table border="0"> <tr> <td><u>FLT/INH mode</u>²</td> <td><u>Digital I/O mode</u></td> </tr> <tr> <td>FLT output</td> <td>OUT 0</td> </tr> <tr> <td>FLT Common</td> <td>OUT 1</td> </tr> <tr> <td>INH Input</td> <td>IN 2/OUT 2</td> </tr> <tr> <td>INH Common</td> <td>Common</td> </tr> </table> ² as-shipped configuration	<u>FLT/INH mode</u> ²	<u>Digital I/O mode</u>	FLT output	OUT 0	FLT Common	OUT 1	INH Input	IN 2/OUT 2	INH Common	Common
<u>FLT/INH mode</u> ²	<u>Digital I/O mode</u>											
FLT output	OUT 0											
FLT Common	OUT 1											
INH Input	IN 2/OUT 2											
INH Common	Common											
RS-232 connector	XON-XOFF RTS-CTS DTR-DSR NONE	uses ASCII control codes DC# and DC1 uses Request-To-Send and Clear-To-Send lines uses Data-Terminal-Ready and Data-Set-Ready lines there is no flow control										
HP-IB connector	HP-IB/IEEE 488	Provides the interface to an external HP-IB controller										
Ac input connector	ac mains	Can be 100 Vac, 120 Vac, 220 Vac or 240 Vac Input										

A3 Front Panel Circuits

As shown in Figure 4-1, the supply's front panel assembly contains a circuit board, a keypad, a liquid crystal display (LCD), and a rotary control (RPG) for the output voltage and current. With the exception of the RPG (A3G1), the A3 Front Panel board is an assembly-level replaceable part. A separate front panel binding post board is also included on the unit. It is also available as an assembly-level replaceable part.

The A3 front panel board contains microprocessor circuits, which decode and execute all keypad and RPG commands that are transferred to the power supply output via the serial I/O port to the primary interface circuits on the A2 interface board. The front panel microprocessor circuits also process power supply measurement and status data received on the serial I/O port. This data is displayed on the LCD.

A2 Interface Circuits

The circuits on the A2 interface board provide the interface between the HP-IB interface, RS-232 interface, and front panel interface and the dc power supply. Communication between the power supply and an HP-IB controller is processed by the HP-IB interface and the primary microprocessor circuits on the A2 board. The A2 Interface board is assembly-level replaceable; it contains no user-replaceable parts.

With the exception of the front panel microprocessor, all digital circuits, analog-to-digital converters (ADC) and digital-to-analog converters (DAC) in the dc power supply are located on the A2 Interface board. All control signals between the A2 interface board and the A1 main board are either analog or level signals.

Primary Interface

The primary microprocessor circuits (DSP, ROM, and RAM chips) decode and execute all instructions and control all data transfers between the controller and the secondary interface. The primary microprocessor circuits also processes measurement and status data received from the secondary interface.

A Dual Asynchronous Control chip on the A2 board converts the RS-232, RI/DFI, and front panel data into the primary microprocessor's 8-bit data format. The serial data is transferred between the primary interface and the secondary interface via a serial bus and optical isolator chips. These chips isolate the primary interface circuits (referenced to earth ground) from the secondary interface circuits.

Secondary Interface

The secondary interface circuits include a programmed logic array, EEPROM, boot-ROM, 8 and 12-bit DAC circuits, and 8 and 16-bit ADC circuits. The programmed logic array translates the serial data received from the primary interface into a corresponding digital signal for the appropriate DAC/ADC circuits. The logic array is also connected directly to four DAC/ADC circuits. Under control of the logic array, the selected DAC converts the data on the bus into an analog signal. Conversely, the selected ADC converts the analog signals from the A1 board into a digital signal.

The logic array also directly receives status information from the A1 main board via three level-sensitive signal lines, which inform the array of the following operating conditions: constant voltage mode (CV_Detect*), constant current mode (CC_Detect*), and overvoltage (OV_Detect*). The PM_Inhibit control signal is used to shut down the bias voltage to the output stages and keep the power supply output off. The OV_SCR* control signal is used to fire the SCR and keep the power supply output off when an overvoltage condition has occurred.

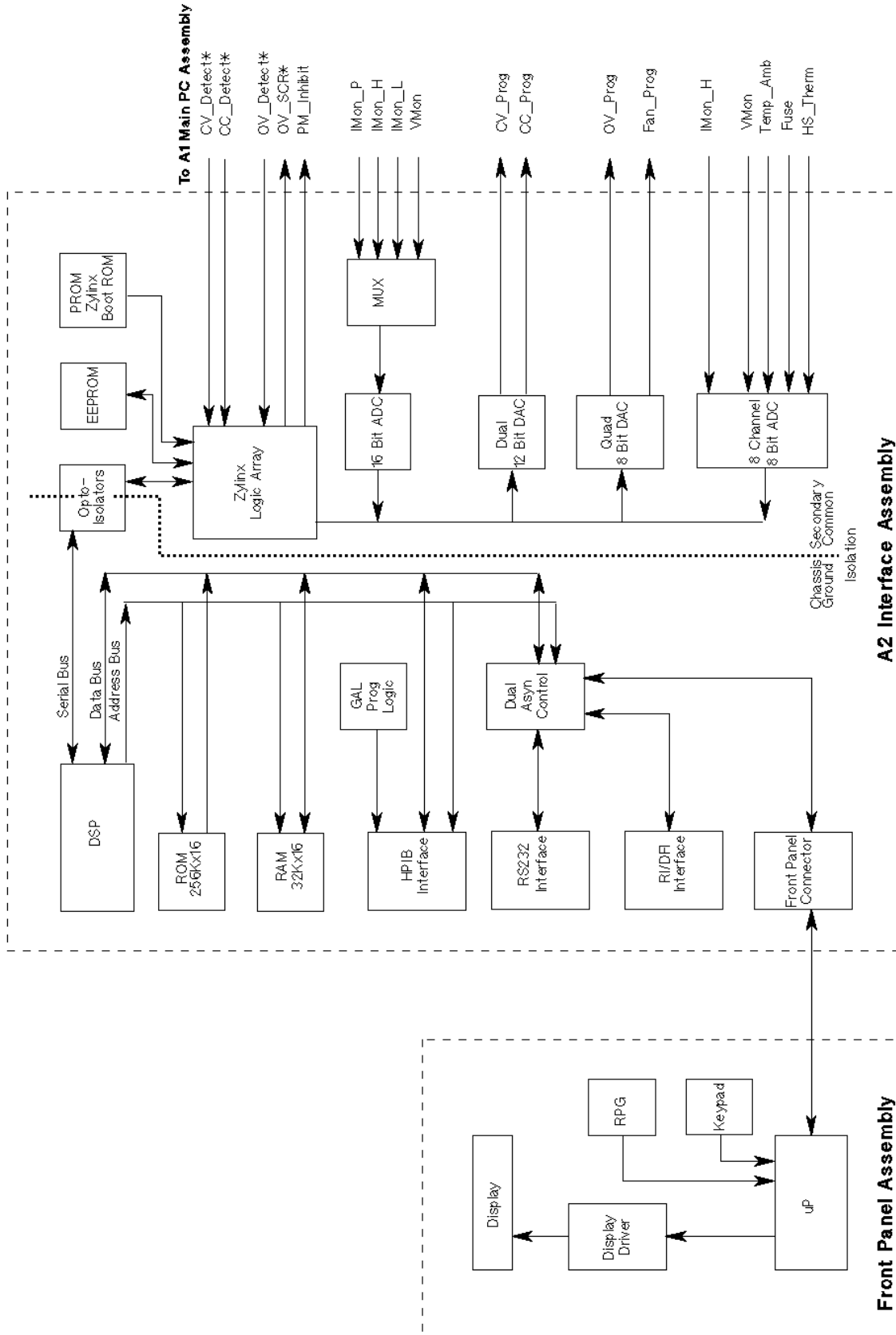

Figure 4-1. A2/A3 Block Diagram

4 - Principles of Operation

The EEPROM (electrically erasable programmable read-only memory) chip on the A2 interface board stores a variety of data and configuration information. This information includes calibration constants, HP-IB address, present programming language, and model-dependent data, such as the minimum and maximum values of voltage and current. One of the EEPROM storage locations holds a checksum value which is used to verify the integrity of the EEPROM data. Access to the calibration data in the EEPROM is controlled by the combination of a password and switch settings on A2S201, located on A2 interface board (see chapter 3 "Inhibit Calibration Switch").

The Dual 12-bit DAC converts the programmed value of voltage and current on the bus into the CV_Prog and CC_Prog signals, which are sent to the CV control circuits in order to control the magnitude of the output voltage in the CV mode and output current in CC mode. The CV_Prog and CC_Prog signals are in the 0 to -5 V range, which corresponds to the zero to full-scale output ratings of the dc power supply.

The Quad 8-bit DAC converts programmed information for the following circuits into analog format: overvoltage setting (OV_Prog), and fan speed programming (Fan_Prog). The OV_Prog signal is applied to the OV detect circuit, which compares the programmed overvoltage setting with the actual output voltage. The Fan_Prog signal is applied to the fan speed control circuit in order to speed up the fan as temperature increases, and to slow the fan speed down as temperature decreases.

The 16-bit ADC in conjunction with a 4x1 multiplexer returns data from the following measurement signals to the logic array: monitored output voltage (VMon), monitored high-range current (Imon_H), monitored low-range current (Imon_L), and monitored peak current (Imon_P). All measurement signals are in the range of 0 to +5V, which corresponds to the zero to full-scale readback capability of the dc power supply.

The 8-channel, 8-bit ADC returns the following signals to the logic array: high-range output current (Imon_H), overvoltage (V_Mon), ambient temperature (Temp_Amb), heatsink temperature (HS_Therm), and output fuse state (Fuse). Four of these signals are for fan control. The logic array varies the Fan_Prog signal depending upon the ambient temperature, the heatsink temperature, and the present output voltage and current. The Fuse signal informs the logic array if the output fuse (F309) is open.

A1 Main Board Circuits

Power Circuits

As shown in Figure 4-2, the power circuits consist of: input power rectifiers and filter, an output regulator, a downprogrammer circuit, current-monitoring resistors, an overvoltage SCR, and an output filter.

The ac input rectifier and filter converts ac input to a dc level. The output regulator regulates this dc level at the output of the power supply. The output regulator stage consists of two parallel NPN series regulators mounted on a heatsink and connected between the +Rail and the +Output. The conduction of these series regulators is increased or decreased by the Control signal from the CV/CC control circuits in order to regulate the output voltage (in CV mode), or output current (in CC mode).

An NPN downprogramming transistor is connected between the +Output and the -Rail. The conduction of the downprogramming transistor is controlled by the DP_Control signal from the CV/CC control circuits. Whenever the output voltage is greater than the programmed voltage setting, the downprogramming transistor conducts and shunts current away from the load until the output voltage equals the programmed setting.

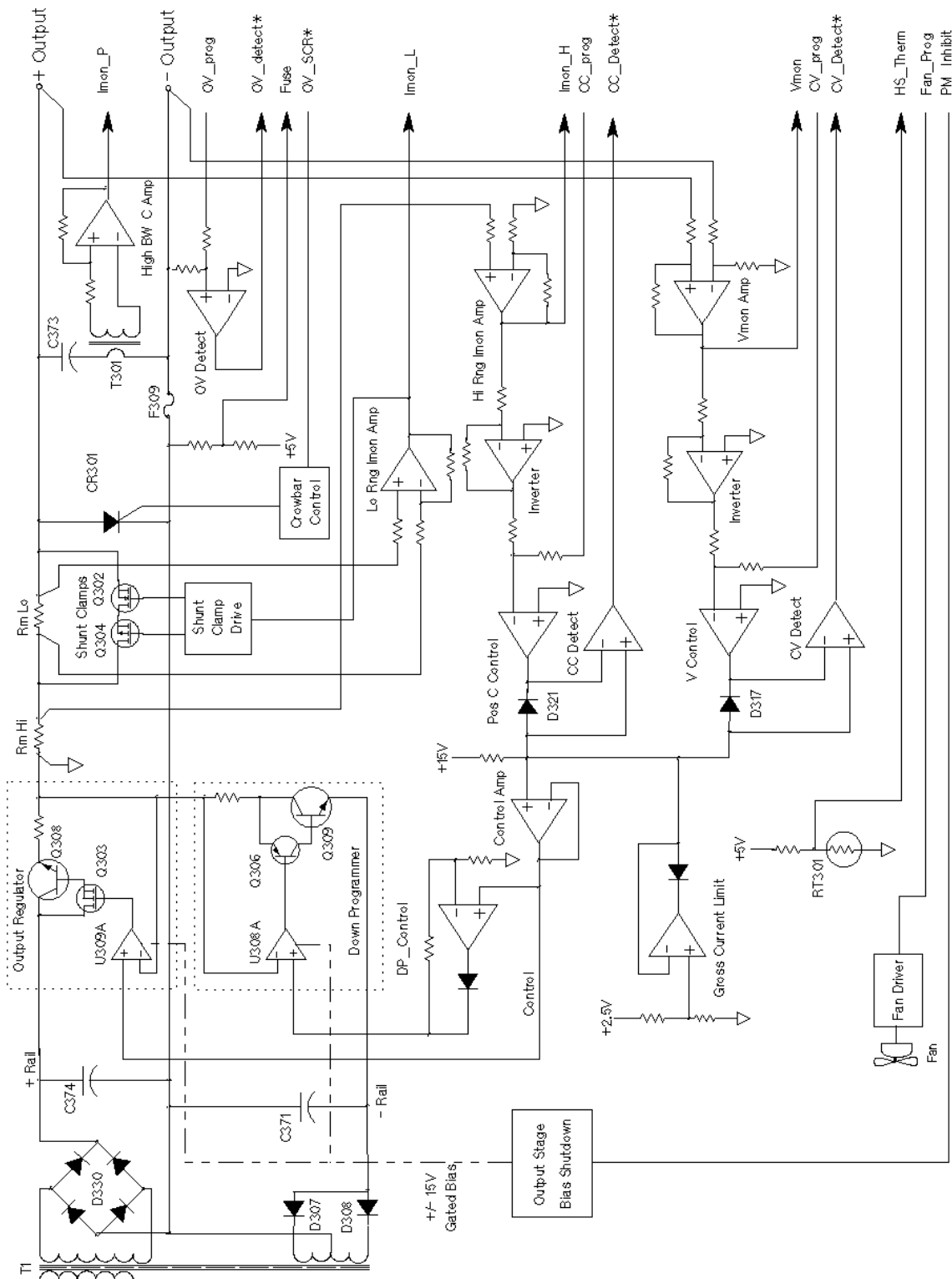

Figure 4-2. A1 Block Diagram

4 - Principles of Operation

The SCR, connected across the output, will fire and short the output when an overvoltage condition is detected. The SCR is controlled by the OV_SCR* signal from the crowbar control circuit (described in the next section).

Two current shunt resistors (RmHi and RmLo) monitor the output current. RmHi monitors the high current range; RmLo monitors the low current range. Shunt clamps are connected in parallel across RmLo to limit the current to approximately 25 mA (the maximum rating of the low current range).

The output filter capacitor provides additional filtering of the dc output.

Control Circuits

As shown in Figure 4-2, the control circuits consist of the CV/CC control, output voltage/current monitor, bias supplies, and SCR control.

The CV/CC control circuits provide a CV control loop and a CC control loop. For any value of load resistance, the supply must act either as a constant voltage (CV) or as a constant current (CC) supply. Transfer between these modes is accomplished automatically by the CV/CC control circuit at a value of load resistance equal to the ratio of the programmed voltage value to the programmed current value. A low level CV_Detect* or CC_Detect* signal is returned to the secondary interface to indicate that the corresponding mode is in effect.

With the CV loop in control, the output voltage is regulated by comparing the programmed voltage signal CV_Prog (0 to -5V) with the output voltage monitor signal VMon. The VMon signal is in the 0 to +5 V range, which corresponds to the zero to full-scale output voltage range of the supply. If the output voltage exceeds the programmed voltage, the Control signal goes low, causing the output regulator to conduct less and decrease the output voltage. Conversely, if the output voltage is less than the programmed voltage, the Control signal goes high, causing the regulator to conduct more and increase the output voltage. Depending upon the position of the Sense switch, the output voltage is either monitored at the supply's output terminals (local), or at the load (remote), using the +S and -S terminals with remote sense leads connected to the load. If the output voltage goes higher than the programmed value, the downprogramming stage is turned on.

With the CC loop in control, the output current is regulated by comparing the programmed current signal CC_Prog (0 to -5V), with the output current monitor signal Imon_H. The Imon_H signal is produced by measuring the voltage drop across current monitoring resistor and is in the 0 to +3.5 V range, which corresponds to the zero to full-scale output current range. If the output current exceeds the programmed value, the Control signal goes low, causing the output regulator to conduct less and thus decrease the output current. Conversely, if the output current is less than the programmed value, the Control signal goes high, causing the output transistors to conduct more and increase the output current. A gross current limit circuit protects the output if the output current exceeds the maximum current rating of the unit.

When the downprogramming stage is turned on (in either CV or CC mode), the CV/CC control circuit causes the Control signal to go low, which in turn causes the downprogramming transistors to conduct current away from the load and speed up downprogramming.

During operation, a PM_Inhibit signal will cause the output stage bias/shutdown circuit to turn off the gated 15 V bias voltages and shut down the output if any of the following occur:

- The output is programmed off.

- An overvoltage condition is detected (OV_Detect* signal is received).

- The line voltage falls below 90 volts (approximately).

Current readback is provided by three separate circuits. The previously discussed high range current signal (I_{mon_H}) returns the high range current measurement. When the unit is operating in the low current readback mode, a separate low range current shunt and amplifier provides low-current readback via the I_{mon_L} signal. A shunt clamp (Q304 and Q305) clamps the voltage across R_{mLo} to approximately 1.8 V. The third current readback circuit consists of a high bandwidth current amplifier that returns dynamic current measurements from the output filter capacitor via the I_{mon_P} signal. Note that the I_{mon_H} and the I_{mon_P} signal are combined to return the actual output current measurement.

An overvoltage detect circuit compares the output voltage to the programmed overvoltage setting. When the output exceeds the programmed setting, the OV_Detect* signal goes low, which informs the logic array that an OV condition has occurred. The crowbar control circuit is enabled when the OV_SCR* signal is received. When an overvoltage condition occurs, the SCR control circuit generates the OV signal, which causes the following actions to occur:

1. The SCR fires, shorting the supply's output.
2. The microprocessor circuits are notified of the OV condition (OV_Detect* is low) in order to program the output off, turn off the 15V bias supply, and update the status of the unit.
3. The PM_Inhibit signal goes high, programming the output off and shutting down the +15V bias for the output regulators.
4. When a output protection clear command is executed, the microprocessor circuits resets the OV circuits, turns on the +15V bias supply, and programs the output to its previous level.

The fan driver control circuit provides the DC voltage to operate the cooling fan. The Fan_Prog signal from the secondary interface circuit varies this voltage according to the ambient and heatsink temperature as well as the output voltage and current of the supply.

Replaceable Parts List

Introduction

This section lists the replaceable parts for HP models 66312A and 6612B. Refer to figures 5-1 and 5-2 for the location of mechanical parts with the reference designators MP. Refer to the board location diagrams in chapter 6 for the location of electrical parts.

Table 5-1. Chassis, Electrical

Designator	Part_Number	Qty	Description
A1	5063-3428	1	Control PCA
A2	5063-3429	1	Interface PCA for 6612B
A2	5063-3439	1	Interface PCA for 66312A
A3	5063-3430	1	Front Panel PCA
A4	06611-60022	1	Binding Post PCA
B1	06632-60002	1	Fan Assembly
G1	0960-0892	1	Rotary pulse generator
T1	9100-5399	1	Main Power Transformer
W-1	06611-80003	1	Primary Power Cable
W-2	06611-80006	1	Interface Power Cable
W-3	06611-80004	1	Secondary Power Cable
W-4	06611-80005	1	Secondary Bias Cable
W-5	06611-80007	1	Output Cable
W-5	06011-80003	1	Magnetic Core
W-6	5080-2457	1	Display Power/Comm Cable
W-7	5080-2452	1	Interface Power Cable
W-8	5080-2448	1	Interface Signal/Bias Cable
W9	06611-60056	2	T1 Primary Jumper
	8120-4383	1	Line Cord, (std U.S. 115Vac input)
	8120-1351	1	Line Cord, Option 900,
	8120-1369	1	Line Cord, Option 901,
	8120-1689	1	Line Cord, Option 902,
	8120-0698	1	Line Cord, Option 904,
	8120-2104	1	Line Cord, Option 906,
	8120-2956	1	Line Cord, Option 912,
	8120-4211	1	Line Cord, Option 917,
	8120-4753	1	Line Cord, Option 918,

5 - Replaceable Parts

Table 5-2. Chassis, Mechanical

Designator	Part_Number	Qty	Description
MP1	06611-00001	1	Chassis
MP2	5063-3413	1	Front Panel
MP3	06611-00003	1	Side Bracket, Left
MP4	06611-00005	1	Side Bracket, Right
MP5	06611-00004	1	Transformer Bracket
MP6	1510-0091	2	Binding Post
MP7	0590-0305	2	Hex Nut 6-32 w/Lockwasher
MP8	33120-87401	1	Knob
MP9	06612-40002	1	Window (6612B)
MP9	66312-40001	1	Window (66312A)
MP10	06611-40001	1	Pushrod (Ref Line Switch)
MP11	06611-40002	1	Keypad
MP12	06611-00002	1	Cover
MP13	03478-88304	1	Rear Bezel
MP14	5041-8801	4	Foot
MP15	0515-0430	13	Screw M4x0.7x8mm, Torx T15, Pan, Conical cup
MP16	5020-2860	1	Main Heat Sink
MP17	1400-1826	6	Spring Clip
MP18	0515-0433	6	Screw M3x0.5x6mm, Torx T10, Pan, Conical cup
MP19	06611-20003	1	Insulator Pad
MP20	06612-20002	1	Thermal Insulator
MP21	0380-0644	2	Stud Mounted Standoff (ref HPIB Connector)
MP22	2190-0586	2	Helical Lock Washer, M4
MP23	3050-0849	2	Flat Washer, #10
MP24	06611-40006	1	Fan Spacer
MP25	0515-0374	5	Screw M3x0.5x10mm, Torx T10, Pan, Conical cup
MP26	06611-40005	1	Support Plate
MP27	06611-80002	1	Rear Panel Label
MP28	1400-0493	1	Cable Tie
MP29	1400-1281	3	Cable Clip
MP30	5001-0438	4	Side Trim
MP31	0515-2535	2	Screw, M3x0.5x8mm, Torx T10, Pan Head
MP32	1252-1488	1	Terminal Block, 4 Position, RI/DFI
MP33	0360-2604	1	Terminal Block, 5 Position, Output/Sense
MP34	0370-2862	1	Pushbutton (Ref Sense Switch)
MP35	1400-0977	2	Battery Clip (Cover Ground)
MP36	1252-3056	2	Screw Lock Kit (ref RS232 Connector)
	5962-0872	1	Operating Guide
	5962-8108	1	Programming Guide
	5962-0874	1	Service Guide

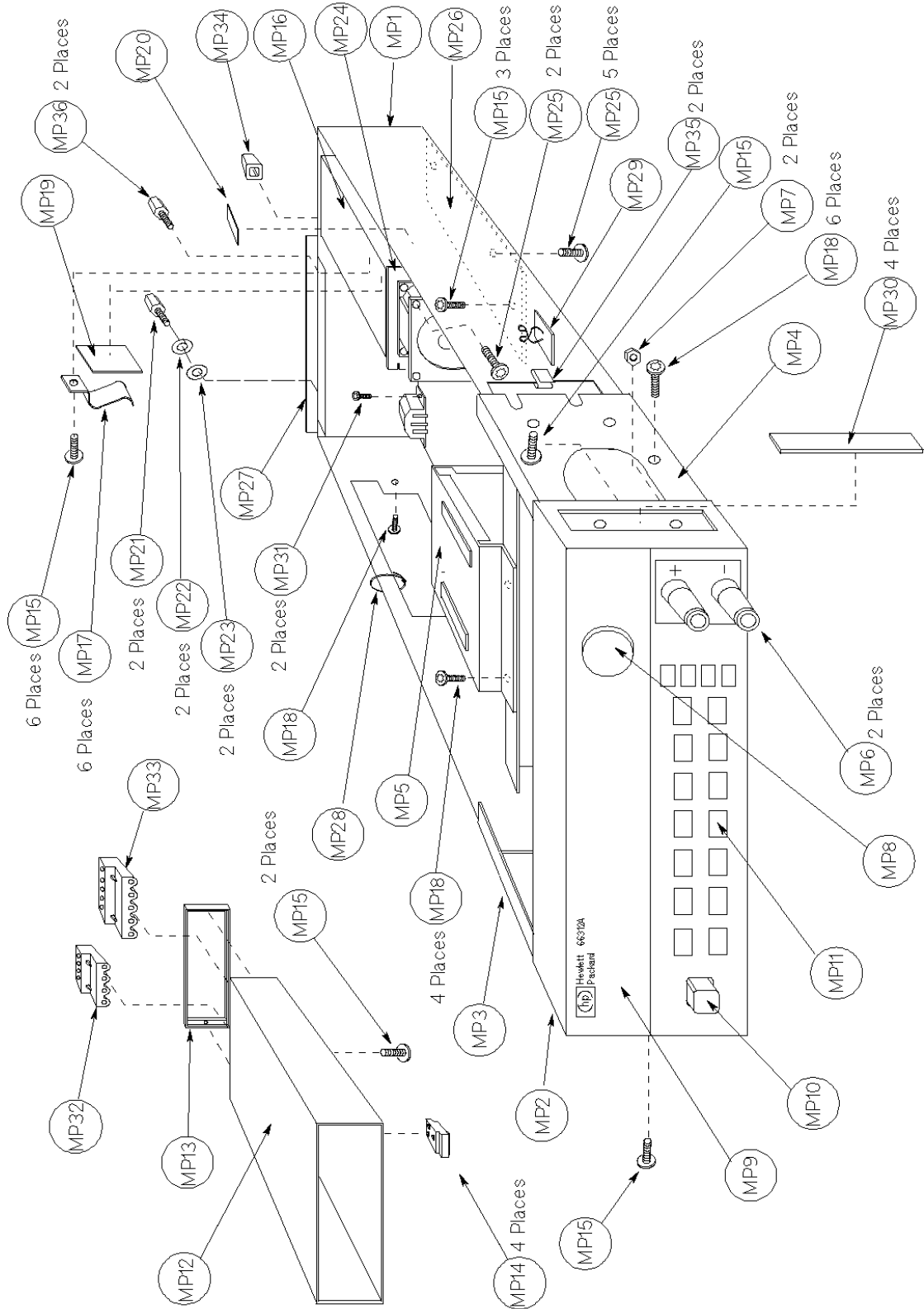

Figure 5-1. Mechanical Parts Identification

5 - Replaceable Parts

Table 5-3. A1 Control PC Board Assembly

Designator	Part_Number	Qty	Description
A1	5063-3428	1	Control PC Assembly
C301, 302	0160-4801	2	Cap 100 pF 5%
C303	0160-5422	1	Cap 0.047 uF 20%
C304	0160-4834	1	Cap 0.047 uF 10%
C305	0160-4846	1	Cap 1500 pF 100V
C306	0180-4129	1	Cap 1 uF 35V
C307	0160-4834	1	Cap 0.047 uF 10%
C308, 309	0160-8180	2	Cap 1000 pF
C310	0180-4136	1	Cap 10 uF 20V
C313	0160-0161	1	Cap 0.01 uF 10%
C314	0160-5471	1	Cap 0.1 uF 5% 50V
C315	0160-4801	1	Cap 100 pF 5%
C316	0160-4833	1	Cap 0.022 uF 10%
C317	0160-4812	1	Cap 220 pF 5%
C318	0160-4801	1	Cap 100 pF 5%
C319	0160-4812	1	Cap 220 pF 5%
C320	0160-4801	1	Cap 100 pF 5%
C321	0160-4833	1	Cap 0.022 uF 10%
C322, 323	0160-4801	2	Cap 100 pF 5%
C324	0160-6827	1	Cap 0.022 uF 400V
C325	0160-4801	1	Cap 100 pF 5%
C326, 327	0160-4791	2	Cap 10 pF 5% 100V
C328	0160-7277	1	Cap 2.2 uF 50V
C329, 330, 331	0160-4791	3	Cap 10 pF 5% 100V
C332	0160-4831	1	Cap 4700 pF 10%
C333	0160-4807	1	Cap 33 pF 5% 100V
C334	0160-4801	1	Cap 100 pF 5%
C335	0160-4807	1	Cap 33 pF 5% 100V
C336	0160-4814	1	Cap 150 pF 5%
C337, 338	0160-5422	2	Cap 0.047 uF 20%
C339	0160-4814	1	Cap 150 pF 5%
C340	0160-5422	1	Cap 0.047 uF 20%
C341	0160-4831	1	Cap 4700 pF 10%
C342, 344	0160-5422	2	Cap 0.047 uF 20%
C345	0160-4807	1	Cap 33 pF 5% 100V
C346 - 350	0160-5422	5	Cap 0.047 uF 20%
C352, 353	0160-5422	2	Cap 0.047 uF 20%
C354	0180-4033	1	Cap 2200 uF 35 V
C355	0180-2980	1	C-F 1000 uF 50V
C356 - 363	0160-5422	8	Cap 0.047 uF 20%
C364, 365	0160-4835	2	Cap 0.1 uF 10% 50V

Designator	Part_Number	Qty	Description
C366	0160-4918	1	Cap 0.022 uF 10%
C367, 368	0160-4835	2	Cap 0.1 uF 10% 50V
C369	0160-5422	1	Cap 0.047 uF 20%
C370	0160-5932	1	Cap 0.47 uF 250VAC
C371, 372	0180-4818	2	Cap 8200 uF 16V
C373	0160-8232	1	Cap 50 uF 30V
C374	0180-4138	1	Cap 8200 uF 50V
C375	0180-0197	1	Cap 2.2 uF 20V TA
C376	0180-4129	1	Cap 1 uF 35V
C377	0160-5422	1	Cap 0.047 uF 20%
C378, 379	0180-4129	2	Cap 1 uF 35V
C380, 381	0150-0081	2	Cap 0.01 uF +80
C383	0180-4129	1	Cap 1 uF 35V
C384	0160-4807	1	Cap 33 pF 5% 100V
C385	0160-4787	1	Cap 22 pF 5% 100V
C386	0160-4511	1	Cap 220 pF 200V
C387	0160-5644	1	Cap 0.033 uF 50V
CR301	06611-60008	1	Assembly-REG/HS
	2200-0143	1	Ref CR301 Machine Screw 4-40
	1884-0310	1	Ref CR301 Thyristor, SCR MCR69-3
	1901-0987	1	Ref CR301 Diode, Power (see CR301)
	0590-0199	1	Ref CR301 Hex Nut W/Lockwasher
	1205-0282	1	Ref CR301 Heat Sink
D301 - 310	1901-0731	10	Diode
D311, 312	1901-1087	2	Diode, Power
D312	1901-0987	1	Diode, Power (see CR301)
D313	1901-1098	1	Diode
D315	1901-0880	1	Diode
D316	1901-0987	1	Diode, Power (see Q304)
D317	1901-1098	1	Diode
D318	1901-0880	1	Diode
D319, 321, 322	1901-1098	3	Diode
D323, 325	1901-0880	2	Diode
D326 - 328	1901-1098	3	Diode
D329	1901-0880	1	Diode
D330	5063-3416	1	Bridge Rectifier Assembly
	0535-0031	1	Ref D330 Hex Nut M3x0.5 w/Lockwasher
	1205-0219	1	Ref D330 Heat Sink
	0515-0374	1	Ref D330 Screw M3x0.5x10mm, Torx T10, Pan
	1906-0349	1	Ref D330 Rectifier

5 - Replaceable Parts

Designator	Part_Number	Qty	Description
D334	1901-0880	1	Diode
D336 - 341	1901-1098	6	Diode
F301	2110-0002	1	Fuse 2A 250V (for 110/120 Vac)
	2110-0007	1	Fure 1AT 250V (for 220/230 Vac)
	2110-0927	1	Ref F301 Fuseholder with cap
F302	2110-0671	1	Fuse 0.125A 125V
F303	2110-0699	1	Fuse, Submin 5A
F304	2110-0671	1	Fuse 0.125A 125V
F305, 306	2110-0699	2	Fuse, Submin 5A
F307	2110-0671	1	Fuse 0.125A 125V
F308	2110-0699	1	Fuse, Submin 5A
F309	2110-0967	1	Fuse, Submin 4 A
F310	2110-0699	1	Fuse, Submin 5A
J303	1251-4245	1	Connector, 2 Pin Male
J304	1251-8512	1	Connector
J305	1252-0063	1	Connector
J307	1252-5977	1	Connector
J308	1252-3771	1	AC Input Connector
J309	1252-7041	1	Connector
J314	1252-0063	1	Connector
CR301	06611-60008	1	Connector
Q301	1854-1330	1	Transistor, NPN
Q302	06611-60007	1	Assembly-REG/HS
	1205-0282	1	Ref Q302 Heat Sink
	1251-3411	2	Ref Q302 Connector
	1855-0831	1	Ref Q302 MOSFET N-Chan
Q303	1855-0725	1	MOSFET
Q304	06611-60006	1	Assembly-REG/HS Q304/D316
	0340-0950	1	REF Q304 Insulator
	0590-0199	1	REF Q304 Hex Nut W/Lockwasher
	2200-0143	1	REF Q304 Machine Screw 4-40
	3050-1021	1	REF Q304 Shoulder Washer
	1855-0726	1	REF Q304 MOSFET P-Chan
	1901-0987	1	REF Q304 Diode, power
	1205-0282	1	REF Q304 Heat Sink
Q305	5060-3245	1	Assembly-HS,REG
	1205-0282	1	Ref Q305 Heat Sink
	1854-0828	1	Ref Q305 Transistor, NPN
Q306	1853-0497	1	Transistor, PNP
Q307	1855-0725	1	MOSFET
Q308 - 310	1854-1174	3	Transistor, NPN

Designator	Part_Number	Qty	Description
R301	0698-3441	1	Res 215 Ohm 1%
R302	0698-3430	1	Res 21.5 Ohm 1%
R303	0698-3441	1	Res 215 Ohm 1%
R304	0683-4725	1	Res 4.7K 5% 0.25W
R305	0698-3441	1	Res 215 Ohm 1%
R306	0683-2255	1	Res 2.2M 5% 0.25W
R307	0683-0475	1	Res 4.7 Ohm 5% 0.25W
R308	0698-3430	1	Res 21.5 Ohm 1%
R309	0698-0085	1	Res 2.61K 1%
R310 - 312	0757-0280	3	Res 1K 1% 0.125W
R314	0757-0316	1	Res 42.2 Ohm 1%
R315 - 319	0757-0280	5	Res 1K 1% 0.125W
R320	0698-0092	1	Res 2.61K 1%
R321	0698-3441	1	Res 215 Ohm 1%
R322, 323	0757-0280	2	Res 1K 1% 0.125W
R324	0757-0317	1	Res 1.33K 1% 0.125W
R325	0698-6360	1	Res 10K 0.1%
R326, 327	0757-0442	2	Res 10K 1% 0.125W
R328, 329	0698-6360	2	Res 10K 0.1%
R330	0698-3496	1	Res 3.57K 1% 0.125W
R331	7175-0057	1	Jumper Wire #22
R332	0698-6360	1	Res 10K 0.1%
R333, 334	0757-0442	2	Res 10K 1% 0.125W
R335	0757-0462	1	Res 75K 1% 0.125W
R336	0698-6360	1	Res 10K 0.1%
R337	0757-0442	1	Res 10K 1% 0.125W
R338	0698-8234	1	Res 12.1K 0.1%
R339	0698-8827	1	Res 1M 1% 0.125W
R340	0698-6533	1	Res 12.5K 0.1%
R341 - 343	0683-0475	3	Res 4.7 Ohm 5% 0.25W
R344	0757-0442	1	Res 10K 1% 0.125W
R345	0698-6630	1	Res 20K 0.1%
R346	0698-3156	1	Res 14.7K 1%
R347	0757-0441	1	Res 8.25K 1%
R348	0698-6392	1	Res 22K 0.1%.125W
R349	0757-0441	1	Res 8.25K 1%
R350	0698-3156	1	Res 14.7K 1%
R351	0757-0442	1	Res 10K 1% 0.125W
R352	0698-3156	1	Res 14.7K 1%
R353	0811-1669	1	Res 1.8 Ohm 5% 2W
R354	0757-0279	1	Res 3.16K 1%

5 - Replaceable Parts

Designator	Part_Number	Qty	Description
R355	0757-0442	1	Res 10K 1% 0.125W
R356	0698-3156	1	Res 14.7K 1%
R357	0757-0442	1	Res 10K 1% 0.125W
R358	7175-0057	1	Jumper Wire #22
R359	0698-3156	1	Res 14.7K 1%
R360	0698-3160	1	Res 31.6K 1%
R361	0698-3162	1	Res 46.4K 1%
R362	0757-0459	1	Res 56.2K 1%
R363	0698-6631	1	Res 2.5K 0.1%
R364	0698-0084	1	Res 2.15K 1%
R366	0757-0449	1	Res 20K 1% 0.125W
R367	0757-0459	1	Res 56.2K 1%
R368	0698-3162	1	Res 46.4K 1%
R369	0757-0455	1	Res 36.5K 1%
R370	0698-0084	1	Res 2.15K 1%
R371	0757-0449	1	Res 20K 1% 0.125W
R372	0698-3160	1	Res 31.6K 1%
R373	0698-0082	1	Res 464 Ohm 1% 0.125W
R375	0698-6631	1	Res 2.5K 0.1%
R376	0757-0340	1	Res 10K 1% 0.25W
R377	0757-0394	1	Res 51.1 Ohm 1% 0.125W
R378	0757-0419	1	Res 681 Ohm 1% 0.125W
R379	0757-0199	1	Res 21.5K 1%
R380	0698-3155	1	Res 4.64K 1%
R381	0757-0419	1	Res 681 Ohm 1% 0.125W
R382	0698-3157	1	Res 19.6K 1%
R383, 385	0757-0199	2	Res 21.5K 1%
R386	0757-1093	1	Res 3K 1% 0.125W
R387	0698-3157	1	Res 19.6K 1%
R388	0757-0419	1	Res 681 Ohm 1% 0.125W
R389	0757-0459	1	Res 56.2K 1%
R390	0698-3155	1	Res 4.64K 1%
R391	0698-3153	1	Res 3.83K 1%
R392	0757-1093	1	Res 3K 1% 0.125W
R393	0699-1972	1	Res 1.74M 1% 0.125W
R394	0698-8816	1	Res 2.15 1%
R395	0698-8827	1	Res 1M 1% 0.125W
R396	7175-0057	1	Jumper Wire #22
R397	0698-3359	1	Res 12.7K 1% 0.125W
R398	0698-8816	1	Res 2.15 1%
R401	0698-3558	1	Res 4.02K 1%

Designator	Part_Number	Qty	Description
R402	0699-2048	1	Res 800K 0.1%
R403	0757-0289	1	Res 13.3K 1%
R404	0757-0465	1	Res 100K 1%
R405	0698-8826	1	Res 825K 1%
R406	0757-0397	1	Res 68.1 Ohm 1%
R407	0757-0199	1	Res 21.5K 1%
R408	0698-7332	1	Res 1M 1% 0.125W
R409	0698-4486	1	Res 24.9K 1% 0.125W
R410	0757-0414	1	Res 432 Ohm 1% 0.125W
R411	0699-1972	1	Res 1.74M 1% 0.125W
R412	0757-0416	1	Res 511 Ohm 1% 0.125W
R413	0698-3279	1	Res 4.99K 1%
R414	0757-0438	1	Res 5.11K 1%
R415	0811-3290	1	Res 0.1 Ohm 5% 2W
R416	0698-4202	1	Res 8.87K 1%
R418, 419	7175-0057	2	Jumper Wire #22
R421 - 423	7175-0057	3	Jumper Wire #22
R425	0699-4484	1	Res 72 Ohms
R430	0686-2225	1	Res 2.2K 5% 0.5W
R431	0811-3771	1	Res 0.25 Ohm 1%
R432, 433	0699-0267	2	Res 10K 0.05% 0.1W
R434, 435	0699-1513	2	Res 40K 0.05% 0.1W
R436 - 438	0699-4707	3	Res 0.25 Ohm 5% 3W
R439	0699-1867	1	Res 3.2K 0.1%
R440	0699-2246	1	Res 25K 0.05%
R441	0699-1867	1	Res 3.2K 0.1%
R442	0699-2246	1	Res 25K 0.05%
R443	0698-8834	1	Res 9K 0.1% 0.125W
R444, 445	0699-1866	2	Res 2.7K 0.1% 0.1W
R446	0698-8834	1	Res 9K 0.1% 0.125W
R447	0698-3456	1	Res 287K 1%
R448, 449	0757-0407	2	Res 200 Ohm 1% 0.125W
R450, 451	0757-0433	2	Res 3.32K 1%
R452, 453	0698-8812	2	Res 1 Ohm 1% 0.125W F
R454	0757-0338	1	Res 1K 1% 0.25W F
R455, 456	0757-0401	2	Res 100 Ohm 1% 0.125W
R457	0757-0407	1	Res 200 Ohm 1% 0.125W
R458	0698-3160	1	Res 31.6K 1% 0.125W
RT301	0837-0397	1	Thermistor
S301	3101-2808	1	Push Button Switch, DPST
S302	3101-2894	1	Push Button Switch, DPDT

5 - Replaceable Parts

Designator	Part_Number	Qty	Description
T301	9100-4350	1	Current Transformer
U302	1990-0543	1	Opto-Isolator
U304	5060-3232	1	Assembly-HS
	1826-0106	1	Ref U304 Integrated Circuit
	1205-0282	1	Ref U304 Heat Sink
U305	5063-2389	1	Assembly-REG/HS
	1826-1597	1	Ref U305 Integrated Circuit
	1205-0402	1	Ref U305 Heat Sink
U306	5060-3229	1	Assembly-HS
	1826-0214	1	Ref U306 Integrated Circuit
	1205-0282	1	Ref U306 Heat Sink
U307	5060-2948	1	Assembly-HS
	1826-0122	1	Ref U307 Integrated Circuit
	1205-0282	1	Ref U307 Heat Sink
U308, 309	1826-1533	2	Integrated Circuit
U311	1858-0077	1	Transistor Array
U312	1858-0076	1	Transistor Array
U315, 316	1826-1533	2	Integrated Circuit
U318, 319	1826-3521	2	Integrated Circuit
U320, 321	1826-1533	2	Integrated Circuit
U322	1826-1878	1	Integrated Circuit
U324	1826-2252	1	Integrated Circuit
U325	1826-3521	1	Integrated Circuit
U326	1826-0962	1	Integrated Circuit
U327	1826-0065	1	Integrated Circuit
U328	1826-1370	1	Integrated Circuit
VR301, 302	1902-0958	2	Zener Diode 10V 5%
VR303	1902-0955	1	Zener Diode 7.5V 5%
VR304	1902-0957	1	Zener Diode 9.1 V 5%
VR305	1902-3092	1	Zener Diode 4.99V 2%

Table 5-4. A4 Binding Post PC Board Assembly

Designator	Part_Number	Qty	Description
A4	06611-60022	1	Binding Post PCA
C601, 602	0150-0081	2	Capacitor, 0.01 uF
C607, 608	0160-4511	2	Capacitor, 220 pF
L601 - 604	9170-1266	4	Ferrite Core
J615	1252-0056	1	Connector, 4 pin

Diagrams

Introduction

This chapter contains drawings and diagrams for troubleshooting and maintaining the HP Model 66312A Dynamic Measurement DC Source and the HP Model 6612B System DC Power Supply. Unless otherwise specified in the drawings, a drawing or diagram applies to both models and input voltage options.

General Schematic Notes

All resistors are in ohms 1%, 1/8 W, unless otherwise specified.

All resistors are in ohms 1%, 1/8 W, unless otherwise specified.

All capacitors are in microfarads unless otherwise specified.

Unless otherwise noted, bias connections to integrated-circuit packages are as follows:

	<u>Common</u>	<u>5 V</u>
14-pin packages	pin 7	pin 14
16-pin packages	pin 8	pin 16
20-pin packages	pin 10	pin 20

Backdating

REVISION “A” boards: The schematic sheets in this manual apply to Revision “B” Control Boards. The revision number of the board is located under the HP logo (next to U302). Revision A boards do not contain the following components that are shown in this manual:

C387, D339, D340, D341,
R353, R331, R358, R396, R458

6 - Diagrams

Table 6-1. A1 Board Component Locations

Ref.	X	Y	Ref.	X	Y	Ref.	X	Y	Ref.	X	Y	Ref.	X	Y
C301	5.125	3.975	C370	1.125	0.625	J303	10.72	2.15	R352	2.4	2.025	R425	4.1	2.4
C302	1.725	3.975	C371	8.925	2.975	J304	10.3	5.35	R353	1.8	3.5	R430	6.275	5.35
C303	10.55	3.7	C372	9.725	1.775	J305	10.45	4.325	R354	2.775	1.425	R431	6.625	2.4
C304	0.75	2.725	C373	1.475	3.575	J307	7.7	1.7	R355	5.15	0.7	R432	2.0	3.05
C305	1.8	2.225	C374	9.1	4.55	J308	0.587	1.368	R356	2.775	1.325	R433	2.0	3.15
C306	8.05	3.625	C375	6.275	3.325	J309	0.256	4.49	R357	1.85	1.4	R434	1.35	2.75
C307	1.55	3.4	C376	8.3	0.775	J314	7.2	5.3	R358	6.5	3.5	R435	1.35	2.85
C308	1.35	1.9	C377	3.5	3.9	Q301	5.495	4.2	R359	2.85	1.725	R436	1.55	5.35
C309	0.95	0.465	C378	8.025	2.2	Q302	3.8	2.8	R360	4.25	0.7	R437	0.475	5.35
C310	6.275	5.15	C379	7.65	2.35	Q303	0.832	4.571	R361	7.825	3.975	R438	4.125	5.35
C313	2.25	0.25	C380	0.475	3.96	Q304	4.85	2.8	R362	5.05	0.25	R439	5.725	2.1
C314	2.5	2.675	C381	1.01	4.285	Q305	7.35	4.925	R363	1.45	3.4	R440	6.175	1.9
C315	3.725	0.875	C383	4.9	4.6	Q307	3.323	4.571	R364	5.75	4.65	R441	6.175	2.0
C316	6.825	3.25	C384	4.025	2.105	Q308	1.339	4.571	R366	3.525	1.325	R442	6.175	1.7
C317	6.75	4.55	C385	4.85	1.75	Q309	2.583	4.571	R367	6.325	0.7	R443	4.7	1.7
C318	6.825	3.875	C386	0.68	3.85	R301	2.625	3.975	R368	4.025	0.7	R444	4.25	1.8
C319	4.3	4.05	C387	5.8	1.075	R302	1.125	3.975	R369	8.475	2.35	R445	4.25	2.1
C320	2.025	3.975	Cr301	3.5	3.575	R303	3.825	4.35	R370	3.225	1.025	R446	4.7	1.9
C321	6.325	2.8	D301	9.0	2.175	R304	8.275	3.975	R371	3.625	0.875	R447	5.25	0.7
C322	6.725	3.875	D302	10.52	3.6	R305	1.525	3.975	R372	5.55	3.525	R448	6.025	3.15
C323	4.5	4.05	D303	9.2	2.175	R306	2.4	2.325	R373	4.35	0.7	R449	6.025	3.05
C324	2.725	0.525	D304	10.35	3.6	R307	6.15	3.525	R375	0.75	2.9	R450	7.025	2.8
C325	4.7	1.6	D305	8.85	2.2	R308	3.7	4.4	R376	10.12	4.5	R451	6.125	3.25
C326	2.025	3.25	D306	8.7	2.25	R309	2.725	3.975	R377	3.5	3.775	R452	4.525	3.3
C327	6.325	2.1	D307	8.7	3.775	R310	7.825	4.85	R378	6.15	4.65	R453	4.525	3.4
C328	4.775	3.325	D308	8.5	3.775	R311	2.525	4.425	R379	7.525	3.975	R454	7.325	1.95
C329	2.0	2.95	D309	10.85	3.6	R312	0.75	3.0	R380	7.825	3.425	R455	5.125	2.175
C330	2.5	2.225	D310	10.67	3.6	R314	4.4	3.7	R381	5.0	4.15	R456	4.775	1.325
C331	5.1	1.975	D311	8.45	4.575	R315	6.4	3.525	R382	6.25	4.2	R457	6.525	0.825
C332	5.65	4.65	D312	3.3	3.275	R316	4.8	4.15	R383	7.625	3.525	R458	5.95	0.8
C333	5.725	0.55	D313	4.55	0.7	R317	1.625	3.975	R385	7.725	3.975	Rt301	1.002	4.944
C334	4.6	2.0	D314	6.425	0.6	R318	3.225	1.225	R386	5.85	4.2	S301	9.757	0.326
C335	6.325	1.65	D315	2.25	2.35	R319	7.525	2.975	R387	6.55	4.65	S302	1.119	3.41
C336	1.9	2.55	D316	5.05	3.1	R320	8.75	1.25	R388	4.125	0.7	T301	3.225	2.325
C337	1.55	1.57	D317	2.85	1.625	R321	7.025	3.525	R389	5.375	0.7	U302	5.225	4.625
C338	1.65	1.575	D318	1.9	2.45	R322	0.6	3.55	R390	7.725	2.975	U304	8.3	3.325
C339	2.05	1.4	D319	4.6	4.05	R323	3.225	0.925	R391	6.65	4.2	U305	8.45	1.15
C340	10.67	4.825	D321	2.775	0.825	R324	4.95	0.25	R392	5.95	4.65	U306	7.35	2.375
C341	8.15	4.125	D322	4.45	0.35	R325	3.375	2.1	R393	2.625	0.875	U307	8.15	2.475
C342	9.42	5.39	D323	2.525	0.475	R326	7.95	1.35	R394	3.475	1.65	U308	4.725	3.975
C344	10.57	5.275	D325	2.175	0.575	R327	2.075	0.5	R395	3.425	0.875	U309	2.125	4.3
C345	6.175	1.8	D326	3.925	0.725	R328	1.75	0.95	R396	0.75	2.8	U311	5.65	3.975
C346	6.4	3.425	D327	5.375	0.45	R329	2.625	0.775	R397	6.225	0.25	U312	7.125	3.975
C347	4.75	0.7	D328	3.625	0.25	R330	2.4	1.825	R398	6.525	3.975	U315	7.45	4.5
C348	0.4	4.1	D329	2.0	2.85	R331	2.95	2.8	R401	6.35	4.65	U316	3.825	1.175
C349	6.925	3.975	D330	8.05	5.275	R332	2.85	2.425	R402	2.85	3.975	U318	6.425	2.1
C350	4.85	0.7	D334	6.225	3.15	R333	2.25	2.0	R403	6.025	2.8	U319	5.2	1.975
C352	6.85	3.325	D335	6.925	2.8	R334	6.825	2.725	R404	5.425	3.975	U320	6.425	3.1
C353	5.1	4.6	D336	7.625	4.95	R335	6.05	4.65	R405	6.45	4.2	U321	5.825	0.55
C354	9.8	3.475	D337	7.075	5.05	R336	3.225	0.725	R406	3.525	0.7	U322	2.2	1.875
C355	10.05	2.8	D338	7.55	2.45	R337	5.575	2.9	R407	6.625	3.525	U324	2.475	1.4
C356	5.575	2.075	D339	4.7	4.5	R338	1.95	1.4	R408	2.625	0.675	U325	3.9	2.05
C357	7.35	4.2	D340	2.025	4.35	R339	1.375	0.225	R409	3.175	1.65	U326	6.625	1.175
C358	7.025	0.875	D341	4.6	4.5	R340	2.35	2.75	R410	3.075	2.1	U327	6.95	4.55
C359	4.45	1.325	F301	0.964	2.379	R341	5.325	3.975	R411	2.35	2.65	U328	5.15	1.125
C360	7.85	4.575	F302	6.05	3.975	R342	1.325	4.425	R412	3.275	1.65	Vr301	2.5	2.125
C361	7.125	1.325	F303	10.35	4.15	R343	1.225	4.425	R413	8.05	4.125	Vr302	2.85	1.925
C362	5.0	1.625	F304	5.225	3.525	R344	6.925	2.725	R414	8.575	2.35	Vr303	7.725	4.95
C363	4.13	2.125	F305	10.42	2.3	R345	2.625	0.975	R415	2.75	3.325	Vr304	7.525	4.95
C364	1.425	3.975	F306	10.45	4.15	R346	3.225	1.125	R416	7.95	4.575	Vr305	8.1	2.025
C365	1.825	3.975	F307	7.475	0.35	R347	7.625	2.975	R418	3.95	3.15			
C366	3.725	0.7	F308	10.02	4.85	R348	1.8	2.1	R419	7.95	3.175			
C367	2.95	3.975	F309	4.1	3.525	R349	3.825	0.7	R421	3.95	3.675			
C368	1.925	4.425	F310	9.925	4.85	R350	4.65	0.7	R422	7.475	2.35			
C369	10.8	1.075				R351	7.025	2.725	R423	7.925	2.65			

Figure 6-1. A1 Board Component Locations

6 - Diagrams

Figure 6-2. A4 Board Component Locations and Schematic

Figure 6-3. A1 board schematic (sheet 1)

6 - Diagrams

Figure 6-3. A1 Board schematic (sheet 2)

Figure 6-3. A1 Board schematic (sheet 3)

Index

—+—
+OUT, 47
+sense, 47

—A—
A1 board removal, 44
A1 Main board, 50
A2 board removal, 43
A2 Interface Board, 48
A2S201, 50
A3 board removal, 44
A3 Front Panel, 48
ADC, 48

—B—
bias voltages, 37, 38

—C—
cal denied, 40
calibration, 40
calibration - post repair, 40
CC, 37
CC line regulation, 17
CC load effect, 18
CC load regulation, 17
CC loop, 52
CC noise, 19
CC- operation, 17
CC source effect, 18
CC_Detect*, 48, 52
CC_Prog, 50, 52
clear password, 40
component locations
 A1, 66
 A4, 68
constant current tests, 16
constant voltage tests, 14
Control, 50, 52
copyrights, 5
cover removal, 43
current monitoring resistor, 13
current sink, 17
CV, 37
CV load effect, 14
CV loop, 52
CV Noise, 15
CV source effect, 15
CV/CC control, 50, 52
CV_Detect*, 48, 52
CV_Prog, 50, 52

—D—
DAC, 48
disable protection, 39
disassembly - tools, 42
disassembly procedure, 42
downprogramming, 50, 52
DP_Control, 50

—E—
EEPROM, 50
electronic load, 13
electrostatic discharge, 10
error codes, 36

—F—
F309, 50
fan speed, 39
Fan_Prog, 50, 52
firmware revisions, 10, 41
FLT, 47
front panel removal, 43
Fuse, 50

—H—
hazardous voltages, 9
history, 5
HP-IB, 47
HS_Therm, 50

—I—
identification, 5
IDN? query, 41
Imon_H, 50
IMon_H, 52
Imon_L, 50
Imon_P, 50
INH, 47
inhibit calibration, 40
initialization, 41
interface signals, 47

—J—
J307 voltages, 38

—L—
line voltage wiring, 44

Index

—M—

manual revisions, 10

—N—

notice, 5

—O—

-OUT, 47
out of range, 40
OV_Detect*, 48, 52
OV_Prog, 50
OV_SCR*, 48, 52

—P—

PARD, 15, 19
password, 40
performance test form, 19
performance tests, 13
PM_Inhibit, 52
power-on self-test, 36
primary interface, 48
printing, 5
programming, 13
protection, 39

—R—

readback accuracy, 14
reference voltages, 37, 38
replaceable parts - A1 board, 58
replaceable parts - binding posts, 64
replaceable parts - chassis, 55
revisions, 10
RmHi, 52
RmLo, 52
ROM upgrade, 41
RPG, 48
RS-232, 47

—S—

safety considerations, 9

safety summary, 3
schematic
 A1, 69, 70, 71
 A4, 68
schematic notes, 65
SCR, 52
secondary interface, 48
self-test, 36
-sense, 47
sense switch, 52
serial number, 5
series regulator, 50
shunt clamp, 52
status annunciators, 37

—T—

Temp_Amb, 50
test equipment, 11
test setup, 12
trademarks, 5
transformer removal, 44
transient recovery, 16
troubleshooting - bias and reference supplies, 37, 38
troubleshooting - equipment, 22
troubleshooting - flowcharts, 22
troubleshooting - introduction, 21
troubleshooting - overall, 22
troubleshooting - status annunciators, 37

—U—

UNR, 37

—V—

verification tests, 13
VMon, 50, 52
voltage programming, 14

—W—

warranty, 2